

25p

The
SHORT WAVE
Magazine

VOL. XXXI

APRIL, 1973

NUMBER 2



WORLD WIDE COMMUNICATION

Radio Shack Ltd ★

London's Amateur Radio Stockists

Just around the corner from West Hampstead Underground Station

Drake has made The Best better!



The New DRAKE TR-4C Transceiver

The Drake TR-4C is a product of years of transceiver experience and design improvements. The resulting performance makes it one of the finest transceivers available. Its operating handiness is not only evident in circuit design, but also in packaging. Compact and lightweight, it is ideal for mobile use, portable excursions, and vacations. USB, LSB, CW or AM operation is at your finger tips with 300 watts P.E.P. of communications power.

INCLUDED FEATURES ;

- **300 Watts PEP** input on SSB, 260 watts input on CW.
- **Complete Amateur Band Coverage** ; 80 through 15 metre bands complete and 28.5-29.1 MHz of 10 metres. Rest of 10 metre band obtained with accessory crystals.
- **Separate Sideband Filters** ; separate USB and LSB filters eliminate oscillator shifting and insure long term carrier vs filter alignment.
- **Nominal 1.7 ; 1 Filter Shape Factor** ; These filters stand among the industry's finest with 6 dB bandwidth of 2.1 kHz (chosen to slice thru QRM), 60 dB bandwidth of only 3.6 kHz and 100 dB ultimate rejection.
- **Provision For Highly Effective Accessory Noise Blanker.**
- **Heavy Irridited Cadmium Plated Chassis.**
- **CW Side Tone Oscillator** for monitoring your CW transmission.
- **Finish** ; scratch resistant epoxy paint.
- **Crystal Calibrator** built-in.
- **VFO Indicator Light** eliminates confusion of which main tuning knob controls the frequency when using an RV-4C remote VFO.
- **Automatic CW Transmit Receive Switching** sometimes called "semi" break-in.
- **Full AGC** with Drake dual time constant system confines a 60 dB signal change to a 3 dB audio change.
- **Effective Transmitting AGC** insures clean SSB output.
- **Solid State Permeability Tuned VFO** for low drift and accurate 1 kHz divisions on all bands. New easy to read dual concentric dials.
- **VOX or PTT** for use on AM or SSB.
- **Receiver S-Meter** automatically switches to indicate transmitting AGC on transit.
- **Transmitter Plate Ammeter** indicates **Relative RF Output** by depressing load control shaft.
- **Adjustable Pi-Network** output circuit.

DRAKE — SALES — SERVICE

SECURICOR ★ COURIER EXPRESS ★ B.R.S. ★ ACCESS ★ BARCLAYCARD ★ UDT

RADIO SHACK LTD.

OPEN 6 DAYS 9-5. CLOSED 1-2 p.m.

188 BROADHURST GARDENS
LONDON, NW6 3AY

Just around the corner from West Hampstead Underground Station

Telephone : 01-624 7174 Cables : Radio Shack, London, N.W.6
Giro Account No.: 588 7151

LOOKING AT THE K.W. ATLANTA

NOTES ON AN HF-BAND
TRANSCEIVER

F. G. RAYER, A.I.E.R.E. (G3OGR)

THOUGH home-built gear is usually run at G3OGR, one corner has been retained for commercial equipment. The need for this arose when making sure that there was always *something* in an air-worthy condition. With home-made apparatus, there often seemed to be something new to try—some new circuit, or modification which would for lesser or greater periods cause a receiver, a transmitter, a PSU or whatever to be temporarily out of use.

This inclination to try something new or different could usually be resisted with commercial equipment. Therefore, a station consisting of the latter could be left in working order—and in fact over the years QSO's have probably been made about equally with home-built and commercially manufactured gear.

Around 1960/61 a K.W. Victor kit was purchased, and made up into the "commercially manufactured" standby. (Though the Victor could be purchased ready-made, as this one was not, perhaps the correct definition would be that of classifying it as a commercially designed item.) This transmitter with a CR-100 remained as the "always air-worthy" section of the station side by side with the home-made section where 6BW6's, 807's, 6146's, 254M's, a solitary 813, TZ40's and other valves came and went, screen grid modulated, anode modulated, carrier controlled, and who knows what else, together with home-made receivers with or without Q-multipliers, bandspread, varieties of product detectors, and other endless variations.

As the K.W. Victor gave excellent results with no trouble at all right up to a belated decision that the commercial always air-worthy gear should be SSB, it is not surprising that the decision was to invest in another piece of K.W. equipment.

This, then, is how the K.W. "Atlanta" came to occupy the position of the old Victor, and has so remained ever since—a matter of only a little over two years (which is actually a brief period, compared with the years the Victor was kept).

What the Atlanta Is

As it would be impracticable to discuss every detail, this must of necessity be brief. The "Atlanta" is a 500-watt p.e.p. transceiver (125w. AM or 350w. CW rating) with two 6LQ6's in the PA, with matching speaker and power supply. There is 3.5-29.7 MHz coverage of the amateur bands, a crystal calibrator, automatic linearity control, grid block keying, optional sideband selection, and the other features usually associated with modern transceivers.

Panel controls are for band selection, grid and PA tuning, RF and AF gain, VFO tuning, coarse and fine loading, carrier balance, microphone gain, sideband

selection, tune-up and CW, calibrator and VFO calibration adjustment, as well as the usual combined S-meter/PA meter. The back panel drop has provision for an external VFO, PA bias adjustment, aerial and external relay.

Receiving, main circuit functions are met by a 12BZ6 RF amplifier, 12BE6 mixer, 6EW6 and 12BA6 IF stages, 6BN8 audio and AGC amplifier, 12AX7 amplifier and 6GK6 output stage. The crystal calibrator takes a 12BA6 and there is an OA2 voltage regulator. When transmitting, apart from stages which do double service in the usual way, there are mixer, 6GK6 driver, and 2/6LQ6 PA stages, with a 7360 beam-deflection balanced modulator. The VFO is transistor, and the carrier oscillator a 12BA6.

All this is cased in the modern day manner, dimensions being about 10½ in. wide, 5½ in. high and 13½ in. deep, the power supply with speaker being 5½ in. wide, and of similar height and depth. Each of the two units weighs about 18 lbs. (See picture opposite).

Receiving

On first trying the equipment in the "receive" mode, the lack of spurious responses was most noticeable. Earlier, a well-known transceiver had been in use, having a 5.2 MHz IF, and with this (incidentally, in correct working order and adjustment) 80m. signals could read S8 on the 20m. band. As an example, when tuned to 14.1 MHz, with the IF at 5.2 MHz and the VFO working LF of the signal frequency, the VFO was on 8.9 MHz—thus, a 3.7 MHz signal mixing with the 8.9 MHz from the VFO also produced 5.2 MHz. As a result, 80m. signals could be tuned in across the 20m. band. This effect was particularly bad with multi-band aerial systems. It arises, of course, from the choice of VFO and IF frequencies, combined with insufficient pre-mixer selectivity to eliminate the 2nd channel response.

This irritating effect was entirely absent in the K.W. "Atlanta"—20m. signals did not have to be sought amid noises from 80m., and it was not necessary to use only a 20m. dipole for this band, as had been needed earlier.

It terms of sensitivity, selectivity, ease of tuning generally, and calibration at 100 kHz points (checked by the crystal) no fault at all could be found. Sensitivity and selectivity were as good as claimed by *K.W. Electronics, Ltd.* and there was a general feeling that anything which could be heard on any band was receivable with this equipment.

Transmitting

The Atlanta has a "Tune" position for the CW switch, which allows tuning the PA at reduced power (SG voltage is reduced). This is mentioned first because an earlier transceiver had no such provision, and initial tune-up was with the PA valves able to draw full power—in fact, if adjustments were not getting nearly right within about 10 seconds, the anodes grew visibly red, and it was necessary to switch off for a short time, then continue. This, perhaps, is not too important when using a dipole which will be correctly adjusted to give a suitable load. But when using an aerial of multi-band type, with a tuner, adjustments of PA tuning, loading, and



tuner controls do take a little time.

So the benefit of the lower-power tune position of the switch was felt to be really worth while. With a tuner and multi-band aerial system, it allows for leisurely adjustment of the tuner, to obtain best reading on an SWR meter between transceiver and tuner, apart from saving the PA valves.

When the equipment was tuned up in the manner described in the quite detailed manual, signal reports are of good voice quality. If a scope is brought out, output looks correct on this.

A complete station, for one band, thus need be nothing more than the transceiver with its power supply, a push-to-talk mike, and a dipole plugged directly in. For other bands, the aerial system naturally has to be changed to suit. It might consist of a multi-band trap dipole, or one of the various well-known multi-band end, or centre-fed, arrangements, with its matching or tuning unit. As would be expected, a transceiver like the K.W. "Atlanta" is *not* suitable for direct operation into an end-fed half-wave, or some such untunable Ae. system.

Given a normal aerial, normal conditions, and normal operating ability such a transceiver can give contact with all continents in practically a single sitting—where the user goes from there is purely a matter of inclination and time available.

Conclusions

Since having the "Atlanta" (over two years) some limitation, awkwardness, or other feeling regarding its working and operation, which might inspire a desire to change it for something else, has simply never arisen.

There it sits, to do its job as called upon. This was the situation with the old K.W. Victor, which gave unflinching satisfaction for a number of years, and was dispensed with eventually only because there is not space enough to keep everything! It is expected that the K.W. "Atlanta" will go on in the same way. In any case, if anything does go wrong, the factory from which it came is no farther across the world than Kent—and one knows that *K.W. Electronics, Ltd.* give a first-class service on their equipment.

MARCONI ATC RADAR OVERSEAS

Marconi Radar Systems Ltd. have gained a £750,000 contract to provide Subang Airport, Kuala Lumpur, Malaysia, with a highly advanced air traffic control capability well suited to cater for the rising volume of air traffic in that part of the world.

The 50-centimetre radar station, the most powerful ever built for civil use, is to be sited 20 miles from Subang Airport on top of a 6,000ft. mountain to give full coverage of the whole of Malaysian airspace. Equipment includes a massive aerial, over 67ft. wide and 13ft. high, which will produce a beamwidth of only 1.7°, giving excellent definition. The transmitter/receiver unit provides a peak output power of 500 kW, and the display system at Subang will use the latest fully-transistorised 16in. fixed coil display, able to accept either raw radar or to plot extracted synthetic radar information. A fully transistorised dual-channel signal processing system will further improve clarity of the radar picture, and ensure more effective coverage under all conditions.

CRYSTAL MICROPHONE AMPLIFIER

LOW OUTPUT IMPEDANCE — LPF
INCORPORATED

A. LANGTON

CRYSTAL microphones of reasonable quality for communication purposes are available quite cheaply; they have a high output, usually several hundred millivolts. To realise this output it is necessary to work into a high impedance. The circuit described here has a very high input impedance and a very low output impedance, useful for working into a long cable, and also includes a low-pass filter, the whole unit being small enough to be built into the case or handle of the microphone. Voltage gain is 0.85.

The input stage is a source-follower and the input impedance of about 30 megohms imposes very little loading on the microphone, enabling full output voltage to be developed. C1 is a bootstrapping capacitor; without this the input impedance is about 3 megohms. The high value of source resistor gives a gain approaching unity, about 0.95. Because of the spread of FET characteristics a potentiometer is included to set the drain current to 0.5 mA (5v. across R4), a value which gives optimum temperature stability. The range of bias should be enough for any MPF103. Items R5, R6, C2 and C3 form an active low-pass filter with a roll-off at 3 kHz. Response is 6 dB down at 3.8 kHz. The BC109 emitter-follower has a high input impedance, necessary for the correct working of the filter. It loads the source follower very lightly and keeps the overall gain as high as possible. Output impedance is very low;

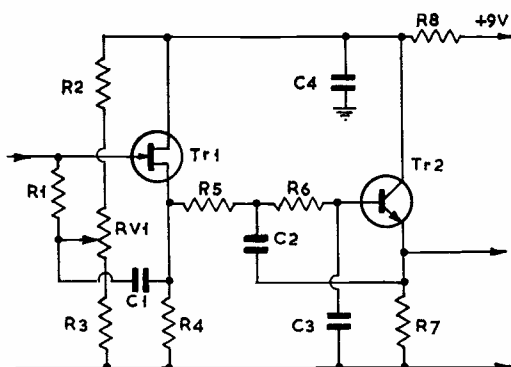

Fig. 1

M
208

Fig. 1. Circuit of Mic. Pre-Amplifier, for which values can be: C1, .068 μ F; C2, .002 μ F; C3, 560 μ F; C4, 50 μ F, 50v.; R1, 3.3 megohm; R2, R5, R6, 47K; R3, 15K; R4, 10K; R7, 2.2K; R8, 470 ohms; RV1, 22K miniature pot'meter; Tr1, MPF103; Tr2, BC109. All resistors rated quarter-watt.

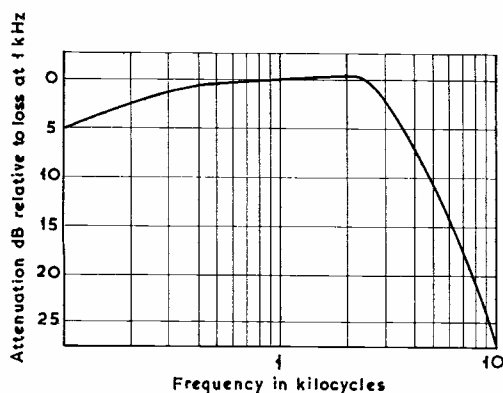

Fig. 2

M
209

Fig. 2. Attenuation-response curve of the Pre-Amplifier discussed in the article.

the preamplifier will deliver 2.5v. peak-to-peak into a 600-ohm load before distortion occurs.

Because of the high input impedance, leads to the microphone must be of low capacity and as short as possible. The ideal is to build the unit into the case using either an etched circuit or 0.1 inch matrix *Vero-board*. Note that the FET lead arrangement is unusual—the gate connection is *not* the centre lead.

RTTY BULLETIN TRANSMISSION

An international news transmission for those able to copy on teleprinter is now being run (from a Danish source) every Thursday evening at 2000z on or near 3580 kHz, using 170-cycle shift.

U.K. LICENCE FIGURES

As at year's end, there were 18,178 U.K. radio amateur licences in issue, taking both categories together. Of these, 3,680 were licensed mobile. The B-licences amounted to 3714/826.

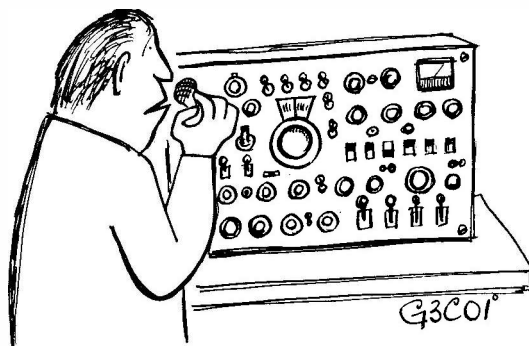

"... changeover here can be a bit complicated ..."

Oscar VI

OPERATION is still erratic, so it looks as if the idea of switching the transponder off during the week in order to give full coverage over the weekends is not working according to plan. There is some evidence that the device is more often operational for orbits to the West of us than for those to the East.

It is well worth while checking orbits which cross 52°N beyond the 2,000 mile range (45° East or West), and even those which do not cross that latitude at all. Those near the North Pole are giving very good results with VE.

Answering CQ calls is proving more productive of contacts than long CQ transmissions. For the newcomer, remember that the Doppler shift frequency may be changing quite rapidly, and that the reply to your CQ may well come on a frequency outside the passband of your Rx, so tune a few kHz each side of your own signal.

Apart from the general comments about the inability to predict when an orbit will be usable, reports indicate that we have now reached the position where it is becoming difficult to find new calls to work. It appears that the novelty has worn off for many operators, particularly in view of the time-wasting chore of setting up the gear(s) for passes which never materialise, and that we are now down to the bedrock of serious effort by devoted observers. Please send reports of all contacts to G2BVN, QTHR, for collation and onward transmission to AMSAT. Special report forms are obtainable from him.

Reports

G3BHW was called by a 9Y4 on orbit No. 1831, but the QSO was clobbered by CQ calls from chaps who had obviously not checked the channel first. The report is of interest, though, as orbit No. 1831 crossed 52°N at 33°W, and if 9Y4 is on, then VP2, VP7 and VP9 should be possible. G3DAH was called by a YK on orbit No. 1550, but that contact was also lost in QRM. GM3ZVB reports hearing an HK, even further afield.

G3NHE has added GM and YU to his score. He has now worked three different YU's after struggling for months to get just one!

VHF BANDS

A. H. DORMER, G3DAH

GM3ZVB, in spite of his low power, has made it with G, DK and F, and with higher power coming along, should provide that long-looked-for QSO with GM for many of us. He reports that the SK4MPI beacon on 2m. went auroral via Oscar during the display on February 21.

G6RH, in an interesting and comprehensive report of his Oscar activities, raises the point about Oscar operators using the top end of the band for CW when communicating through the device. Since working through the satellite is an international exercise, and since such transmissions occur but briefly throughout the day, this practice is unlikely to cause serious QRM to operators in Zone D. Such "bend-

ing" of the Zone Plan need not, therefore, be criticised on this score. Perhaps more serious is the adoption, on a more permanent basis, of frequencies in Zone D by various nets and groups in the South, with the consequent interference to DX contacts with GI and GM.

Bob Holmes also confirms the phenomenon reported by G5ZT that there appears to be an inordinate time delay in the receipt of the 10m. return signals from the transponder which cannot be accounted for by the satellite/earth range. He notes further that he has heard his own signals 3-5 minutes after the predicted orbit time when the pass has been over the North Pole, i.e. at the end of S/N transit.

SWL Gordon Smith in Aberdeen sends in an impressive list of prefixes heard which includes FC6ABP, GM3ZBE, LX1FI and EP2, to bring his total to 34.

Tables

Orbital Predictions, as heretofore, are for crossing times at 52°N, but may be related *approximately* to equatorial crossings by deducting about 40 minutes from them for a N/S pass and about 15 minutes for a S/N path. The maximum duration of any pass is about 23 minutes.

G3COJ and G6RH among others have drawn attention to the fact that European Russia and the Ukraine have several different prefixes and it has now been decided that the Operating Results Table shall show *prefixes* worked, so future claims for inclusion in the Table should take account of this

OSCAR VI — Prediction Data

Orbit	Date	Time (GMT)	Position	Direction
2173	Apr. 7	0747	30°E	N/S
2174		0942	2°E	N/S
2175		1137	27°W	N/S
2176		1658	43°E	S/N
2179		1853	15°E	S/N
2180		2048	14°W	S/N
2186	Apr. 8	0647	45°E	N/S
2187		0842	17°E	N/S
2188		1037	12°W	N/S
2192		1753	29°E	S/N
2193		1948	1°E	S/N
2194		2143	29°W	S/N

Times shown are for crossings at 52°N. Orbits beyond 45° E or W are not included. To calculate later orbits, deduct 5.15 minutes and add 1.29°E each 25 orbits. Orbits shown are for weekend operations only in view of the revised AMSAT procedure.

decision. Confusion is the more confounded because of the change of callsign allocation in Russia, for example UA3KAA, a Club call, has now become UK1AAA, and the procedure we are now adopting will take care of this.

The Operating Results Table has the air of getting unwieldy, and consideration is now being given to publishing it at less frequent intervals or in a shortened form. Perhaps it would continue to sustain interest if only the more unusual prefixes were included? As a try-out this month, herewith the *additions* to the results already published.

OSCAR VI TABLE

Station	Countries	Prefixes	
G6RH	33	UR	(326)
G3WPO	33	GI, GM, UT, SV	(379)
G3BHW	33	UB, UY, 4X4	(312)
EI6AS	32	UA	(437)
G3NHE	32	GM, UK	(426)
G3COJ	30	EA, OE, ON, OZ, TF, UR, VE, YU	(128)
G4AJC	27	HG, LZ, OE, OZ, UK, UR, YU	(191)
G3DAH	21	HG, LZ, UA	(106)
G4ATX	20	EI, GI, LA, LZ, OZ, UR, W	(89)

Aurora

A very informative report and analysis of the two-metre Aurora of February 21/22 comes from GM2DRD. First indications of possible *Ar* activity were visual displays in Forfar at around 1800 hrs., and a quick check on Ch. IV TV showed that there was a radio effect also. Initially, contacts were made with Northern European stations outside the country, and it was not until after 11 p.m. that the first Southern G stations began to appear, contacts then being made with G3CCH, G3LTF, G3JYP and G3TQZ at signal strengths between 5 & 8A. The manifestation on the next day was much weaker, the visual display also being limited, and the only contact to the South was again with G3LTF, although PA, LA and GM were worked at similar signal strengths to those of the previous evening.

GM3ZVB (Edinburgh) was also in on this Aurora, and logged G, GM, GW, DL, DM, OZ, PA and LA. His 8-ele. beam is tilted at 30° to the horizontal for Oscar operation, and although one might have expected that this would lead to improved reflection from the elevated auroral curtain, Robert observed no particular gain from this.

Over in Bridgend, South Wales, GW3ZTH worked GM3ZVB and GM3UAG with GM3ZVL as a gotaway. Both he and GW3WRE observed that signals peaked between 2330z and 0030z, so it looks as if, as usual, the phenomenon in the South appeared later, and was usable for a shorter time than in the North.

Contests

February saw the last of the 432 MHz Cumulatives and propagation conditions for all the seven sections seem to have been almost uniformly poor, a result not unexpected at this time of the year. As a stimulus to activity it can hardly be claimed that they succeeded, as an exercise in frustration, they did! Better luck next time!

Conditions were patchy for the 144 MHz CW event on February 4. Generally, more DX was being worked in the afternoon than in the morning, since it was then that the Continentals appeared. DJ9DL and DC6EQ were working up into the Midlands with good reports both ways, and several PAØ were available. G3NEO in Sheffield was logged working DL5BV, and G3BA made it with DJ1KA. GC2FZC was putting a good signal into the North. Best scores heard were around the 60 mark, which does not indicate a very high level of activity for an event of this duration and mode.

The 70 MHz Open on February 18 was also somewhat disappointing due to poor conditions, although G3VPK (Witham, Essex) was heard having a scratchy, albeit successful, QSO with GM. Two Welsh portables, GW4ABR in Newtown, Mon., and GW4BUC (Wrexham) seemed to be doing pretty well from their elevated sites, while the rest of us plodded on, and considered ourselves lucky if we broke the 50 mark.

The weekend of March 3/4 saw the 144/432 MHz Open and the 144 MHz Fixed Station events running

concurrently for much of the time, and this has provoked some criticism from both fixed station operators and from the portables. The former were faced with the choice of staying off the air on the Saturday in order to have the chance of working the DX portables on the Sunday, risking thereby a drop in propagation and so poorer scores, or going on and working the portables, so denying themselves the chance of getting a few points from them the following day. From the point of view of the portable station operator, the situation was confusing and time-wasting, since DX stations outside the contests, whom they had worked on the first day, were calling them again the following day and either had to be ignored, or worked without gaining any further points. Since more than one band was involved the confusion was compounded.

Conditions on 2m. were above average on both days, the nearer Continentals being available for much of the time, and a surprise opening into HB9 around 1 a.m. on the Sunday morning caught many on the hop. The HB9 beacon was at good strength for a couple of hours or so, and HB9ADJ/P in DG56j and HB9AEN/P in DG13b, both up around the 3,000 metres a.s.l. mark, were really having themselves a ball working G and GW. A few German stations made a brief appearance around midday, as did some French and Dutch stations. 70 cm. was poor and activity low.

Although, without knowing the range, contact scores do not mean much, it may be interesting to note that the West Kent Club, operating as G3WKS/P in Rutland, fared as follows: 2m., 217 contacts in 6 countries and 35 counties, best DX PAØJOU/P at 495 km; 70 cm, 28 contacts in 2 countries and 16 counties, best DX GW4BBP/P (Merioneth) at 197 km.

A problem was raised by several AM station operators in the Midlands who were transmitting in Zones A and B and creating plenty of QRM for their neighbours. Stations were heard in the South operating in the top half of the band and calling for DX contacts in the North. They had obviously never heard the QRM up there at close quarters. Both these practices are

largely self-defeating, and observance of the geographical Band Plan, which was created to avoid this sort of situation, would not only have been desirable and more productive, but would also have been less anti-social.

IARU Region 1 Contests

The 2m. contests in September and October last year were but poorly supported from the U.K. For example, there were only five British stations for the whole of the 364 entries in the 144 MHz Fixed Station section, and possibly the coincidence of national events accounts for this. Congratulations must go to G3OHH who, in 45th place, led our field. The situation was a little better in the 144 MHz Portable section, where there were eight British entries, headed by GW3BA/P, out of 303. However, there were 8 U.K. stations in the first 16 of 50 entries for 432 MHz/P section, and here, as in previous years, GW3LTF/P headed the list. It was on 1296 MHz that we really came into our own. All but 15 entries of a total of 49 were from this country, and we filled the first 15 places. GW3LTF/P was again first in the field. Nice going!

Forthcoming Events

Look out for the 70 MHz portable on April 15 and the 144/432 MHz Open during May 5/6.

The Mid-Severn Valley Teleprinter Group have a 2m. contest on May 13. Details from G3NUE, *QTHR*.

Conventions

For those who may have missed the reminder last month, the 19th International VHF/UHF/SHF Convention takes place at the Winning Post Hotel, Whitton, Twickenham, Middlesex on Saturday April 7, to be followed by discussion groups on Sunday between 1000-1400 hrs. Lectures, trade show, bring-and-buy sale and raffle as usual. Tickets are available from A. Wheeler, (35 Doughty Street, London, WC1N 2AE) at £2.25 including the dinner, £2 for dinner only and 50p for lectures only. See you there!

The UK FM Group (London) held their 1973 Convention at Weybridge on February 24. Some 170 amateurs turned up to hear an interesting

THREE BAND ANNUAL VHF TABLE

January to December, 1973

Station	FOUR METRES		TWO METRES		70 CENTIMETRES		TOTAL Points
	Counties	Countries	Counties	Countries	Counties	Countries	
G4BEL	8	2	42	8	23	4	87
GD2HDZ	12	2	40	5	10	2	71
G3DAH	14	2	40	8	5	1	70
G3OHH	23	2	30	4	8	2	69
G3NHE	—	—	43	7	13	2	65
G2AXI	20	2	33	3	6	1	65
G8FUI	—	—	42	5	15	2	64
G8EOP	—	—	33	3	26	2	64
G3FIJ	13	2	26	5	12	1	59
G8FMK	—	—	30	2	16	1	49
GW3ZTH	—	—	37	7	—	—	44
G3BW	—	—	37	6	—	—	43
G4AEQ	—	—	25	2	13	3	43
G3SMU	10	3	5	2	16	3	39
G3XDY	—	—	27	7	—	—	34
G4AJE	—	—	28	5	—	—	33
G4BKG	—	—	28	4	—	—	32
G8CBU	—	—	23	2	5	1	31
G8GNC	—	—	28	2	—	—	30
G8BXX	—	—	20	1	8	1	30
G8COG	—	—	23	3	—	—	26
GM3ZVB	—	—	21	4	—	—	25
G8DGR	—	—	16	2	6	1	25
GW3DOL	—	—	20	4	—	—	24
GM3ZVL	—	—	16	6	1	1	24
G8DOT	—	—	20	3	—	—	23
G8BKR	—	—	14	2	4	1	21
G8EMS	—	—	16	2	2	1	21
G8GBV	—	—	14	2	3	1	20
G3WHK	—	—	17	3	—	—	20
G4AEZ	—	—	16	1	—	—	17
G8FUL	—	—	13	2	—	—	15
GW8CMA	—	—	11	3	—	—	14
G8GXE	—	—	12	1	—	—	13
G3EKP	4	2	2	1	2	2	13
G8GJB	—	—	10	1	—	—	11
GW8CGH	—	—	7	2	—	—	9

The Table shows claims to date from January 1st, 1973. It will run through to December 31, 1973. Your claims should be sent to:—"VHF Bands," SHORT WAVE MAGAZINE, BUCKINGHAM, MK18 1RQ, as they accrue.

programme of lectures by various experts which, presumably by design, had little to do with mobile FM operation—the possible exception being that given by G3SXX, who dealt with the technical and operating aspects of the Cambridge repeater. Of the 60 odd mobiles present, a quick check showed that about 80% were on FM and 20% on AM, but the talk-in stations were equipped to deal with both modes. This was a well-run affair, and Mike Tooley, G8CKT, and his team are to be congratulated on making it so.

The Scottish VHF Convention this year will be held in Edinburgh on September 29. The venue is likely to be the University. Full details nearer the time.

The Scottish Scene

GM3FYB and GM6ZV have joined the ranks of the "Liner 2" operators. The former, in particular, should have little trouble putting a good signal into G from his excellent Dunfermline site. GM3BQA has now got a 4CX250B linear for SSB which is going great guns.

About The VHF Spectra

GM3TNT operates from the radio station at Rhu Staffnish in Kintyre and, having been to the site, your conductor is not in the least surprised to hear that he is laying down a fine 4-metre signal into G, GI and EI, so his request for skeds on that band should be productive well down to England—*QTHR*, and s.a.e., please.

GM3BCD has a 2m. transceiver almost complete and is proposing to take it with him on holiday and so add a Scottish accent to the Continental QRM. GM3ZVL is now fully QRV on 70 cm. using a solid-state 2m. transceiver to drive a BA110 varactor tripler, giving him 100 mW out at present although higher power is envisaged. The tripler also acts as a mixer on receive with 288 MHz injection to give an output on 2m. for the converter and this makes for a very compact

installation. The beam is an 18-ele. at 40ft.

News Items

Four Metres

Norman Guy, G2DN, reports that he has heard from G3FET/ZC4 that he will be continuing his tests on 70 MHz during March, April and May this year, although he will be able to listen at weekends only and cannot give any specific times. After May, the situation should be a little easier and he will quote exact listening periods. Now that ZB2VHF is back on the air, he should *not* be called on 70-26 MHz. These tests reinforce the argument that ZB2VHF should be moved from the mobile calling channel on 4m.

Two Metres

GW3ZTH (Bridgend) has now got his 4CX250B linear on the air, and is joined in SSB operation by GW8BXQ/A in Pembroke Dock and GW8CFU (Haverford West)—a couple for the DX-chasers. Geoff Spencer, GW8FOL, is also up on SSB from Anglesey with a '640A running about 80 watts p.e.p. to a 10-ele. at 60ft. He is willing to arrange a sked with anyone wanting Anglesey; s.a.e. to *QTHR*.

John Standen, now G4BSU and ex-G8AGL, is up on 2m. SSB from near Pidsea in Yorks. and reports that he has received an OK from MPT to transmit SS/TV on the band. G8DGR, Newbury, Berks. has finished the 4X150A linear which gives him some 90 watts of AM (series gate mod.) and FM.

G3XBY is using a 15-turn helix antenna on 2m. and, in spite of the fact that it is only 6ft. above ground at present, is getting good results. Although there is a cross-polarisation loss associated with this type of antenna, it is not great and, in view of the simple construction and the considerable gain which can be obtained from a helix, it seems odd that more use is not made of the



D. Holding, G8EDL, with Brian Coleman, G8AZU (right), presented a persuasive and convincing talk on getting going on 70 centimetres at the U.K. FM Group (London) convention at Weybridge on February 24 last. G8AZU was a member, with G8APZ and G8DKK, of the team which did so much last year to popularise Seventycems by their Sunday forays with /P gear to attractive DX sites.

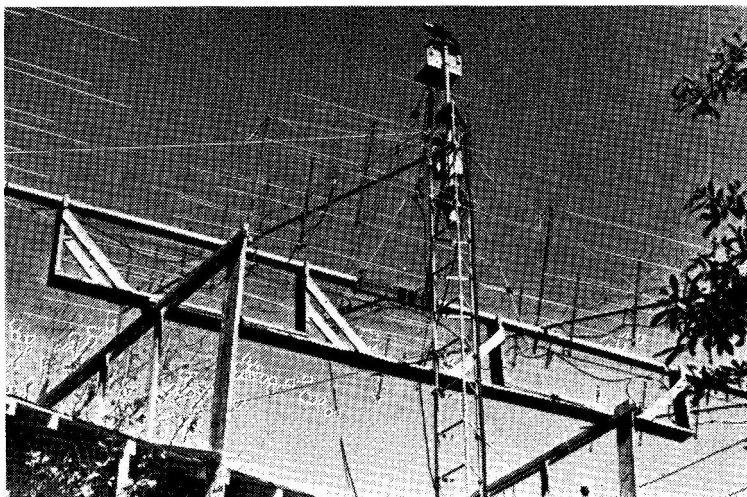

Bob Sutherland, W6PO, of 4040 Fernwood Street, San Mateo, California 94403, U.S.A., is one of the several W6's keen on E-M-E working—for which he has built this very elaborate 430 MHz antenna system. He would be much interested to hear from U.K. operators who would care to discuss skeds.

principle, particularly on 432 MHz and above.

G3DAH (Herne Bay) will be temporarily QRT on this, and all other bands, from March 24 preparatory to a move of QTH.

70 Centimetres

G8BYV (Norfolk) has found 70 cm. conditions to have been better this year than last. He has already had some good DL and PA contacts, and his skeds with G8BAV over a 160 km path have been holding up well. He also reports good reception of the DJ2LF beacon on 432.080 MHz and the German repeater around 432.5 MHz. Judging by the reports coming in, this is contrary to the general experience, and one can only hope that the openings will become more widespread. Certainly, the unusual temperature and pressure conditions on March 10 produced some very nice G and EU DX, with G3KMS in Bolton and G3NHE in Sheffield

at remarkably good signal strength for long periods in the South. G3VZO has now been appointed beacon keeper at Durham, so it should not be *too* long before we have the 70 cm. beacon on 432.05 MHz operating from there, and this should provide a useful addition to the beacon service. (Still no news of resumption of operations from GB3GEC). Continental beacons which should be receivable in this country are: DL0SZ on 432.008 MHz; OZ7IGY, 432.018 MHz; PA0VD, 432.025 MHz; DL1XV on 433.0 MHz; and DL7HGA, 433.485 MHz.

G8EMS in Leeds is now QRV again on 70 cm. after a rebuild. He runs 36 watts input to a '320A, antenna is a Multibeam at 45ft. and Rx a *Microwave Modules* converter into an Eddystone 888A. He would like to hear from anyone more than 100 miles from his QTH who might wish to run skeds during the Easter holidays.

DX-Peditions

G4BRT and G8FHB will be operating from various good sites in GM between March 30 and April 8. They will have FM and SSB on 2m. and AM/FM on 70 cm. Frequencies in accordance with the Band Plan. They will open up on 2m. each evening at 7 p.m. and QSY to 70 cm. if requested to do so. They will call on 70 cm. between 9 and 9.30 p.m. in any case.

GM8EKF will be operating portable from Jersey during April 1-8. Transmission will be AM on 144.390 MHz.

Deadline for the next issue is **April 6**. The address for news, views and comment is: "VHF Bands," SHORT WAVE MAGAZINE, BUCKINGHAM, MK18 1RQ. Cheers for now and *vy 73 de G3DAH*.

Editorial Note: Because of severe mail dislocation (due to the railway trouble) during the critical period, some correspondence arrived too late for this feature.

THE MOBILE SCENE

Following are the dates for the coming Season's Mobile Rally fixtures—there may be a few more to come, for which we should have details as soon as possible.

Note that, after a hiatus of a couple of years or so, the Amateur Radio Mobile Society (A.R.M.S.) is getting back into the Rally scene with plans to lay on a big event "somewhere in the Midlands" on June 17, venue to be notified later.

The Preston Amateur Radio Society now tell us that their Rally up in Lancashire will be on August 19, instead of as previously notified.

April 1: Annual White Rose Rally, at the High School, Ring Road, West Park, Leeds 16, junction of the A.6120 (ring road) and A.660, opening at 11.30 a.m.—R. J. Nettleton, 129 Stainbeck Lane, Leeds, LS27 2EB, for details.

April 15: North Midlands Mobile Rally at Drayton Manor Park, near Tamworth, as last year.

May 6: Tulip-Time Rally, at Sunfleet on the A.16, four miles north of Spalding, Lincs.—Informaton from R. Harrison, G3VPR, 38 Park Avenue, Spalding, Lincs.

May 13: South Leicestershire Mobile Rally at Westfield Activity Centre, Rosemary Way, Hinckley, opening at 11.0 a.m. Talk-in by G3ZOP/A on Top Band, G8CGW/A on two-metre AM/FM, and G3WPB/A on 2m. SSB. There will also be a bring-and-buy stall. Trade stands are to be organised and applications are invited. Details from J. Elliott, G8CGW, 92 Hinckley Road, Barwell, Leicester.

May 20: RAIBC gathering at the Fairground, Broadlands Estate, Romsey, Hants., in conjunction with the Southampton Group—Mrs. Frances Woolley, G3LWY, Woodclose, Penselwood, Wincanton, Somerset.

May 20: Otley Radio Society's Northern Mobile Rally at Moor Grange School, Ring Road, Leeds, offering all the usual attractions.—D. G. Mott, 17 Newall Carr Road, Otley, Yorkshire.

May 27: Hull & District Mobile Rally at Bishop Burton, near Beverley, Yorkshire. Organiser L. D. Colley, G3AGX, 13 Ferry Road, Wawme, Nr. Hull, HU7 5XU, East Yorks.

May 27: Maidstone Mobile Rally at YMCA Sports Centre, Melrose Close, opening at 11.0 a.m. All main events under cover, talk-in by GB3YSC on 2-4-80-160m. Contact A. S. Walter, G3WXL, 4 Oak Farm Gardens, Headcorn, Kent.

June 10: The fourth Elvaston Castle Mobile Rally in the grounds of the Castle Country Park, off the B.5010 south-east of Derby. Talk-in on 2-4-160m. by G3EEO and G3ZBI. A bring-and-buy sale and

various other attractions.—I. Cage, G8GBV, 25 Petersham Drive, Alvaston, Derby, DE2 0JU.

June 17: Amateur Radio Mobile Society Rally in the Midlands—*details later.*

June 24: West of England Mobile Rally at Longleat House, near Warminster, Wilts. This will be the usual good show, put on for many years now in a particularly attractive setting—the house and park alone are well worth a visit.—Rally details from A. H. Williams, G8CKJ, 58 Britannia Road, Kingswood, Bristol.

July 8: Upton-on-Severn Mobile Rally, organised by the Worcester & District Amateur Radio Club. Details: B. A. Jones, G8ASO, 12 Woodside Road, Larkhill, Worcester, WR5 2EG.

August 12: Torbay annual Mobile Rally at Newton Abbot Rugby Club ground, with talk-in, the usual stands and competitions.—L. H. Webber, G3GDW, 43 Lime Tree Walk, Newton Abbot, Devon.

August 12: The 1973 Mobile Rally at Derby, organised by the Derby & District Amateur Radio Society, to be held at the Rykneld School in Bedford Street, as in previous years. Ample accommodation if wet, free entrance and plenty of parking space, many attractions for all comers. This is a well-established annual event, which regularly attracts a large attendance.—F. C. Ward, G2CVV, 5 Uplands Avenue, Littleover, Derby, DE3 7GE.

August 19: Preston (North Lincs.) Annual Mobile Rally at Kimberley Barracks, Deepdale Road, Preston, Lincs., with free car park, trade stalls, refreshments and a bring-and-buy offering. Talk-in will be given on Top Band and two metres.—Contact man G. W. Earnshaw, G3ZXC, 12 Withy Parade, Fulwood, Preston, Lincs., PR2 4JN.

August 26: Town & Country Festival Rally, National Agricultural Centre, Kenilworth, Warwickshire.

September 23: Harlow & District Mobile Rally, this year at Netteswell School, Harlow, to give more space and scope for their activities.—V. Heard, 106 Vicarage Road, Harlow, Essex.

* * *

SOLO MOBILE EXPEDITIONS

The idea for these was outlined on p.34 of our last and the dates chosen are Sundays, from about noon till 5.30 p.m. or so, on April 8, May 20, June 10 and July 11. Please report results, giving location or area covered, band(s) used and best contacts made as soon as possible after these dates to: "Solo Mobile", SHORT WAVE MAGAZINE, BUCKINGHAM, MK18 1RQ.

THE MONTH WITH THE CLUBS

By "Club Secretary"

(Deadline for May issue: April 5)

(Please address all reports for this feature to "Club Secretary", SHORT WAVE MAGAZINE, Buckingham.)

YOUR conductor, this month, having nothing of any importance to say, we will refrain from saying it and get down to the reports!

Nationals

Here we might as well make a start with **Nigeria**, still with us, happily, despite their dire predictions. And, which is maybe more important, one notices a footnote in the current *Newsletter*, which makes it seem likely that at last there is some faint prospect that new licences may be granted in the foreseeable future. This is something which, if it comes to fruition, could revitalise the whole society.

The big news for **R.A.I.B.C.** is the organisation of their Picnic at the Fairground, Broadlands Estate, Romsey, Hants, to take place on Sunday, May 20. It is understood that trains from London will be met at Romsey if prior notice is given. By road, the Fairground is at the A.27 on the Romsey By-pass. That our invalid and bedfast colleagues should be able to look forward to such a social event is thanks to Lord Louis Mountbatten for use of his land, and the Southampton Group who will be taking on the duties of "heavy gang" for the day.

Now to **A.R.M.S.** who cater for the mobile enthusiasts, by way of *Mobile News* each month and much besides. The issue in front of us carries a good piece on the selection of a site for /P operation, with its radio properties in mind.

The writer was rather amused by the **B.A.T.C.** magazine this time, covering the method of reporting on TV signals for which the simple RST is inappropriate. Their code is a BT one with B detailing the picture carrier qualities and T the sound. They define B9 plus as being a situation where the signal is so strong that 400 volts AC should be available from the aerial feeder!

Talking of humour, one always finds some in the **R.N.A.R.S. Newsletter**, these naval types being unable to survive for long without it!

West Country

Here we make a start with **Yeovil** who have their place at the Youth Centre, 31 The Park, and foregather there every Thursday evening. April 12 is the big date for the coming month, when G3XFW is to give a talk on the Club 144 MHz transmitter. Looking forward a bit, we note the Annual General Meeting comes up on May 10.

Talking of AGM's the **Cornish** group have theirs on

April 5, at the SWRB clubroom at Pool, Camborne. In addition to the main meeting there is an offshoot of the club at Newquay—Treviglas School, on April 4 and 18—and another, newly formed, at Penzance. The latter are, as yet, without a Hq. place, so if you want to make contact with them, a contact either with the secretary (see Panel, or, in this special case, with G3UCQ, *QTHR*) will give the very latest news on the venue, and the meeting dates; until the Hq. problem is settled, these can only provisionally be noted as the second Tuesday and the fourth Thursday in the month.

Port Talbot have their Annual Social on April 10, at the Rail and Transport Club, Station Road—admission is free and any amateurs, and their YL's or XYL's, are welcome. The normal meetings of the group are also at this venue, on the second Tuesday in each month; and they try always to maintain a good and varied programme.

Hereford meet at the County Control, Civil Defence Headquarters, in the ominously-named Gaol Street, in the town. For April, we notice they have a film show—quite possibly dealing with Ultrasonics—on the 6th, and a Quiz on the licence regulations part (Part I) of the R.A.E. comes on the 20th.

Southerly

It seems quite a while since last we heard from **Havering**, although we knew they were progressing well. Now we have some more details, which tell us they are at the British Legion Hq., 54 Western Road, Romford, Essex, with bookings for April 4 and 18. On the first of these NFD will be discussed and to pick up on other points of club business, while the 18th will be for G3KFW to tackle RF Measurements and Digital Frequency Meters.

April 18 is also the date for **Verulam**, in their temporary meeting-place in the Market Hall, St. Albans. G8FNT, who is an Applications Engineer with Plessey, will be talking about that company's range of micro-circuits.

A change of Hq. has necessitated a change of date also, at **Reigate**. The new place is the Committee Room, St. Mark's Church Hall, Alma Road, not far from Reigate station; the Hall is at the back of the church, and is approached through the drive on the left of the church itself. This is the venue for the Annual General Meeting, on April 17, which is a "must" for all members. Also in April, there is the Informal session, this being at the

“Marquess of Granby,” on April 3—the latter venue, by the way, is in nearby Redhill. The annual dinner and dance also falls in April, on the 14th, at Russ Hill Hotel.

Kingston have also moved their home base, to the 3rd Tolworth Group Scout Hut, Stirling Walk, Raeburn Avenue, Surbiton, at the rear of Surbiton Lagoon. April 11 is the date, and the subject will be Circuit Board Techniques.

We do not appear to have the latest details from **Mid-Sussex** as to exactly what is going on in April, but we know the general arrangement is one of get-togethers on alternate Thursdays in the month, at Marle Place, Leylands Road, Burgess Hill. If you are thinking of turning up, perhaps a telephone call or letter to G3RXJ (address as Panel) would be a good idea to get the latest gen.

No vagueness about **Sutton and Cheam**—it's the Annual General Meeting on April 17, at “The Harrow” Cheam.

The venue for the **Southgate** session in April is, as usual, the Civil Defence Hut, Bowes Road, opposite the

Arnos Grove Piccadilly Line station, the date to watch for being Thursday, April 12. However, at the time of writing, the detailed programme for the evening is not known—doubtless the hon. secretary (see Panel) could assist here.

On to **Edgware**, at the Watling Community Centre, 145 Orange Hill Road. April 12 is a Constructor Contest; April 26 is Informal; and a hint of warming weather coming is given by the note that they also have a D/F event down for Sunday, April 15, starting at 2.30 from Queensbury Circle.

It is always nice to hear from a Club whose scribe radiates confidence in the group he represents, in the way **G8AAT** does for **North Bucks**. From his letter we get it that they get together on the second Monday in every month at the Wolverton Youth Club. This makes it April 9, and the speaker **G3BA**, talking about DX-peditions. As an added attraction there is a visit to the Telephone Exchange at Bedford on April 16.

The **Worthing** hon. secretary writes to let us know that the Borough Council have agreed to print a further

Names and Addresses of Club Secretaries reporting in this Issue :

ACTON, BRENTFORD & CHISWICK: W. G. Dyer, G3GEH, 188 Gunnersbury Avenue, Acton, London, W3-8LB.
A.R.M.S.: N. A. S. Fitch, G3FPK, 40 Eskdale Gardens, Purley, Surrey, CR2-1EZ.
BARKING: H. G. Davidson, G3FZP, 223 Salisbury Avenue, Barking.
B.A.T.C.: J. J. Rose, G6STO/T, Pinchbeck Farmhouse, Mill Lane, Surton-by-Stow, Lincs. (Stow 356.)
BISHOPS STORTFORD: E. P. Essery, G3KFE, 17 Ascot Close, Parsonage Lane, Bishops Stortford (S2501), Herts.
BOLTON: S. MacDonald, G4AQB, 8 Archer Avenue, Bolton (20668), BL2-2SJ.
BRISTOL: J. Hooper, G3XEI, 207 Stockwood Lane, Stockwood, Bristol, BS14-8NF.
BURY & ROSSENDALE: J. D. Clifford, G4BVE, 10 Arley Avenue, Bury, BL9-5HD, Lancs. (061-764 3466).
CHELTENHAM (Group): E. Janes, G2FWA, Hillside, Bushcombe Lane, Woodmancote, Cheltenham. (Bishops Cleeve 2229.)
CHILTERN: F. Rose, G2DRT, 84 Cock Lane, High Wycombe, Bucks. (Penn 4240).
CORNISH: H. Webster, G3XTF, Crandale, Gillyfields, Redruth (6905).
COVENTRY: G. A. Whenham, G3TFP, Lavernock, 33 Chapel Street, Bishops Itchington, Warks.
CRAY VALLEY: P. F. Vella, G3WVP, 78 Hurst Road, Sidcup, Kent.
DERBY: F. C. Ward, G2CVV, 5 Uplands Avenue, Littleover, Derby (21931), DE3-7GE.
DERBY (Nunsfield House): I. Cage, G8GBV, 25 Petersham Drive, Alvaston, Derby, DE2-0JU.
DUNSTABLE DOWNS: C. G. Powell, G8BPK, 1 Wenwell Close, Buckland Wharf, Aston Clinton, Aylesbury (630600).
ECHELFORD: V. W. Higgs, G3VWJ, 205 Commercial Road, Staines, Middlesex, TW18-2QT.
EDGWARE: A. J. Masson, G3PSP, 62 Coldharbour Lane, Bushey, Herts., WD2-3NY. (01-950 6827.)
GOVERNMENT COMMUNICATIONS H.Q.: E. A. Fowles, G3PEO, C/5617, GCHO, Priors Road, Oakley, Cheltenham.
HARROW: L. Light, G3KDL, 22 Chippenhams Avenue, Wembley, Middlesex.
HAVINGING: S. J. Hobday, G3SKV, 31 Sackville Crescent, Harold Wood, Romford, RM3-OEJ, Essex.
HINCKLEY: J. Elliott, G8CGW, 92 Hinckley Road, Barwell, Leicester.
HEREFORD: S. Jesson, 181 Kings Acre Road, Hereford.
HERIOT-WATT UNIVERSITY: C. J. Dewar, GM8FWS, c/o Heriot-Watt University, Edinburgh.
KINGSTON: R. S. Babbs, G3GVU, 28 Grove Lane, Kingston-on-Thames. (01-546 2801.)
LINCOLN: F. Day, G4BXL, 5 St. Marks Avenue, Cherry Willingham, Lincoln (51058), LN3-4LX.

MIDLAND: N. Gutteridge, G8BHE, 68 Max Road, Quinton, Birmingham 32. (021-422 9787.)
MID-SUSSEX: E. J. Letts, G3RXJ, 87 Meadow Lane, Burgess Hill (3552), Sussex.
NIGERIAN: E. A. Lomax, 5N2ABG, P.O. Box Kaduna 68, Nigeria.
NORTH BUCKS: R. J. Pye, G8AAT, 7 Meadow View Pottersbury, Towcester. (Yardley Gobion 640.)
NORTHUMBRIA: R. J. Thompson, 19 Park Road, Lynemouth, Morpeth, Northumberland, NE61-5XH.
PORT TALBOT: F. C. Rudd, GW4BIQ, 96 Pennard Road, Pennard, Swansea.
R.A.I.B.C.: Mrs. F. Woolley, G3LWY, Woodclose, Penselwood, Wincanton, Somerset.
REIGATE: F. H. Munday, G3XSZ, 2 Conifer Close, Reigate (43130), Surrey.
ROYAL NAVY: CRS A. G. Walker, Hon. Sec., RNARS, H.M.S. Mercury, Leydene, Hants.
SHEFFORD: C. L. Davies, G8DUY, 17 Brigham Gardens, Biggleswade, Beds., SG18-0LW.
SOLIHULL: K. Fretsome, G4ABV, 116 Rowood Drive, Damsonwood, Solihull, Warks.
SOUTHGATE: J. Batchelor, G3XMV, 22 Faversham Avenue, Bush Hill Park, Enfield, Middlesex. (01-360 6537.)
SOUTH MANCHESTER: D. Holland, G3WFT, 7 Alcester Road, Sale, Cheshire, M33-3GW.
STAR: T. Leeman, G4BUU, 115 Asket Drive, Seacroft, Leeds, LS14-1HX.
SURREY: S. A. Morley, G3FWR, 22 Old Farleigh Road, Selsdon, South Croydon, CR2-8PB. (01-657 3258.)
SUTTON & CHEAM: J. Korndorffer, G2DMR, 19 Park Road, Banstead.
VERULAM: H. Young, G3YHY, 93 Leaford Crescent, Watford, WD2-5JQ, Herts.
WEST OF SCOTLAND: M. Parks, 6 Stamperland Hill, Clarkston, Glasgow, G76-8AE. (041-644 1783.)
WHITE ROSE: D. Foster, G3WFS, 23 Norwood Place, Leeds 6.
WIGAN: D. Bussell, G8CRG, 26 Norbeck Crescent, Springfield, Wigan (41385), WN6-7RF.
WIRRAL: A. Fisher, G3WSD, 34 Glenmore Road, Oxtou, Birkenhead, Cheshire. (051-652 5078.)
WOLVERHAMPTON: J. P. H. Burden, G3UBX, 28 Coalway Road, Wolverhampton, WV3-7LX.
WORCESTER: B. A. Jones, G8ASO, 12 Woodside Road, Larkhill, Worcester (2v208), WR5-2EG.
WORTHING: G. Hooper, G8ETL, 12 Bramble Crescent, Durrington, Worthing (62913), Sussex.
YEOVIL: D. L. McLean, G3NOF, 9 Cedar Grove, Yeovil, Somerset.
YORK: K. R. Cass, G3WVO, 4 Heworth Village York.

For many years now, the president of Derby & District Amateur Radio Society has been the eminent surgeon Mr. A. G. G. Melville, FRCS, here seen (on right) presenting his annual trophy to Brian Goodall, G8BUB, at Derby's recent dinner and dance. On this occasion, the prize was for the D/F Contest.



supply of QSL cards for free issue to interested amateurs. For details, contact G8ETL, *see* Panel, and at the same time he will give you the rundown on the latest goings-on at the Club.

Every Thursday you will find the **Barking** crowd at their new venue at Westbury Recreation Centre, Westbury School, Ripple Road, and, indeed, on Tuesdays too, if you are keen to learn Morse at the class held on the latter evening. The highlight for April will come on the 5th, when they have the tape-and-slide lecture on ARRL Headquarters.

One of our "regular customers" comes next, from **Acton Brentford and Chiswick**, whose Secretary has been the same since before your conductor started this piece. He writes this month to say the meeting is on April 17, at 66 High Road, Chiswick, the home of the Chiswick Trades and Social Club. The matter in hand is by way of a general discussion of members' problems.

The Midlands

This clip starts at **Hinckley**, where the newly-formed group has already about *sixty* members on its books. In the near future we notice they have a Mobile Rally, at Westfield Activity Centre, Hinckley, on May 13. In the way of more usual activities, they assemble on April 11 for a talk on Direction Finding, and April 25 is set aside for G3NLY to take SWL Aerials at HF for his theme; both these two are in the Demonstration Room at Hinckley Technical College, at 7.30 p.m.

A change of headquarters for **Worcester** means that for the time being they will be gathering the clans at the Old Pheasant in New Street, Worcester, where they have a private room available. Monday, April 2 sees the Chairman, G3WGY, talking about VHF Techniques,

while on April 14 comes the annual Construction Contest.

We seem to have got out of step with the **Solihull** news, having only last month's details to hand. However, we know they have Hq. for the formal meeting at the Manor House, High Street, and an informal at the Malt Shovel in the same street of Solihull. For dates, and the rest of the gen, we must refer you to G4ABV—*see* Panel, opposite.

At **Wirral** they are for the moment getting together at the Community Centre, Carr Bridge Road, Woodchurch, as their usual place is for five months to come undergoing a major facelift. For April, we note a talk on the "Latest from Solid State" slated for April 4 and a pre-NFD session on April 18. In addition there is a visit to R.A.F. Sealand for a Quiz on April 12.

Friday is the night for **Coventry**, at Baden-Powell House, St. Nicholas Street, Radford Road. The advertised programme runs rather like this: April 6, a lecture on Horticulture(!); April 13 and 20, both Nights-on-the-Air; while on April 27 there will be a demonstration and lecture organised by the well-known firm of J-Beam Aerials.

South Manchester are keen chaps, with a meeting on

CLUB SECRETARIES — ALERT!

Closing dates for this feature for the next few months will be April 5, May 3, June 7 and July 5, for arrival at the following address: "Club Secretary", Short Wave Magazine, Buckingham, MK18 1RQ. Late reports cannot be taken in.

each Friday and Monday. Friday is the main event, with Mondays given over to VHF, at the club shack at "Greeba," Shady Lane, Manchester 23. Looking at the Fridays, we see March 30 for a Mystery Talk by G3HZM; April 6 a Home-brew Mini-Hi-Fi by G3WFT; April 13 a talk about VHF working through *Oscar VI*; a blank on April 20 (for Easter); and on April 27 a Home-Construction Contest.

Open Day

The Open Day each year at GCHQ, Cheltenham has by now become one of the events of the year for those who can attend. This year's will be at the Canteen, GCHQ, Benhall, Gloucester Road, Cheltenham, starting at 7.30 p.m. The usual high standard of exhibits will be maintained and there will also be a bumper raffle. Ample car parking is available. If you can make an appearance on **Friday, April 27**, you should make the effort, as the show will be well worth seeing.

Scotland and North

It is pleasing to hear, as we do from Lincoln, that

their attendances are once again rising, as new members join and old ones put in a re-appearance. On April 4 G3EBH takes up the subject of Aerials, and on the 11th there is an Open Night. April 18 is given over to films, and they mention that they have booked some good ones for this. As for April 25, this is down for a Treasure Hunt.

Some months ago we mentioned the re-formation of a group at Wigan and we now hear from them again. They have alternate Thursday evenings, at the Poolstock Cricket Club pavilion, and by the sound of it there is plenty of enthusiasm and drive about—Good! The main need in the way of new members at the moment is for licensed types, to balance the large influx of keen SWL's.

A private room in the White Lion, Moor Lane is the home of the Bolton crowd, where they get together on the third Tuesday in every month. New members, says the Hon. secretary, G4AQB, will also be very welcome here.

If you want to get to know the Bury and Rossendale lads, you must find the George Hotel, Market Street, Bury, on the second Tuesday in each month. The April 10 date is given over to a talk on HF Aerials by G3JAG.

A special-event station signing GB3MSF will be on the air from Morpeth Spring Festival between April 17 and May 5, says the letter from Northumbria, the group running it. The normal meetings of the Club are held at 3 Wheatsheaf Yard, Morpeth, every Thursday evening.

Nunfield House Community Association, Derby, has its own Amateur Radio Group, which seems to be very active, particularly in the field of construction projects for members, and also direction-finding events. (The latest details on meetings are announced on Friday mornings on the local "Radio Derby," for the meeting that evening). The Hq. is at the Community Associations place at Nunfield House, Boulton Lane, Alvaston, Derby. For April, we have a D/F Practice Run on the 1st, followed by the inquest on Project No. 2 on the 6th; the 13th and 20th are still open at the time of writing; on the 27th there is a bring-and-buy sale.

Every Wednesday night sees the Star Club get together, but on the first meeting of the month there is something special organised, usually a tape-and-slide talk, the current series being from Mullard and including such subjects as History of Radio/TV Transmitters, Receiving Equipment and so on. Visitors and new members are all welcome, at the New Inn Hotel, Bramley Town Street, Leeds 13.

Up to Scotland now, to the West of Scotland lads; they have Wednesdays set aside for constructional projects, VHF, and problem-shooting, while the Friday evenings see them at lectures, films, demonstrations, and so on, not to mention the Morse classes on the same evening. Looking forward a little, we notice the Annual General Meeting coming up on May 5, at 81 Virginia Street, Glasgow G2. This seems a very active and keen group, with a strong organisation.

It is quite a time since we heard from the Heriot-Watt University, Edinburgh, where, we now understand from GM8FWS things have been set back in motion again. Anyone interested in becoming a member should get in touch with him—QTH as in Panel, p.110.

SHORT CLUB NOTICES

CLUB NAME	HEADQUARTERS LOCATION	MEETING MONTHLY
Bishops Stortford	British Legion Club, Windhill	April 16
Bristol	24 Bright Street, Barton Hill, Bristol	April 3, 10, 17, 24
Cheltenham Group	Royal Crescent Hotel, Clarence Street	April 5
Chiltern	Ernest Turner, Ltd., Totteridge Avenue, High Wycombe	April 10, 24
Cray Valley	Congregational Church Hall, Court Road, London, S.E.9	April 5, 19
Derby	119 Green Lane, Derby	April 4, 11, 18, 25
Dunstable Downs	77 High Street South, Dunstable	April 6, 13, 27
Echelford	St. Martins Court, Kingston Crescent, Ashford, Middlesex	April 9, 26
Harrow	Harrow Sea Cadets Hq., Woodlands Road, Harrow	April 6, 13, 27
Midland	Midland Institute, Margaret Street, Birmingham 3	April 17
Sheffield	Church Hall, Ampthill Road	April 5, 12, 26
Surrey	"Swan and Sugarloaf," South Croydon	April 17 (AGM)
White Rose	83 Town Street, Armley, Leeds 13	April 4, 11, 18, 25
Wolverhampton	Neachells Cottage, Stockwell End, Tettenhall	April 2, 9, 16, 30
York	British Legion, 61 Micklegate	April 5, 12, 19, 26

N.B.— in each case, the Secretary's name and address appears in the Panel, p.110.

Members of the Cornish Amateur Radio Club looking over one of the transceivers they used for the recent Marconi anniversary occasion, from Poldhu site. This picture well suggests the wild and rugged coastline down in West Cornwall.



Finale

We seem once again to have come to the bottom of the pile of reports; your next letters should detail the events your group are running in the month of May, to be of most publicity value, and should include the dates, the details, and the address of the Headquarters—if it is a bit hard to find, some directions might help. Finally, of course, we want the name and address of the Secretary, both for the Panel, and also for our files, in case we have a letter from an SWL looking for a Club in your area. The deadline for next time is **April 5**, addressed to "CLUB SECRETARY," SHORT WAVE MAGAZINE, BUCKINGHAM, MK18 1RQ. Till then, 73.

* * *

Editorial Note: Again this month, numerous Club reports were received too late. This was

not altogether the fault of the scribes/hon. secretaries concerned, because the continuing rail dislocation had been causing long delays (sometimes up to five days) in the delivery of even 1st class mail.

Because it is never mentioned by the *media* (which concentrate on commuters' difficulties in the London area) it is simply not understood by the great majority of people that the Post Office moves the mails mainly by train and not by some private communications system of its own—though vans are, of course, used where no rail connections exist.

Anyway, it was just not possible for us to hold up this feature to accommodate late arrivals, because we ourselves have tight deadlines to meet if the issue is to be out on time.

N.R.S.A. ANNUAL CONVENTION

This year the Northern Radio Societies' Association Annual Convention will be held at the Forum Hall, Wythenshawe, Manchester on Sunday, May 6, 11.0 a.m. till 6.0 p.m. The hall is on the south side of Manchester, a few minutes off the M.56 and with good approaches from the centre of the City. Manufacturers and distributors of Amateur Radio equipment will be exhibiting and the member-societies of the Association will have individual stands. Talk-in will be given on 2-4-160m., signing GB2NRS. Raffle tickets for a bumper draw will be available during the day. For further information: P. Taylor, G8BCG, 2 Columbia Avenue, Gorton,

Manchester, M18 7LG.

INTERESTING CLUB RESULT

From the latest *Chiltern Carrier*, newsletter of the Chiltern Amateur Radio Club, we get it that their marker generators (a kit assembly distributed privately) produced a gain of £117 on a turn-over of £673 for the project. The Club's profit on operations for the year was £104—so obviously it was their enterprising scheme that made that possible. The next such project in hand is a frequency-counter and a 200 MHz pre-scaler. We note, however, that there was a small loss on their Mobile Rally last year.

*"Short Wave Magazine" covers the whole field of Amateur Radio
and should be obtainable to order through any newsagent.*

NEW QTH's

This space is available for the publication of the addresses of all holders of new U.K. callsigns, as issued or changes of address of transmitters already licensed. All addresses published here will be reprinted in the U.K. section of the "RADIO AMATEUR CALL BOOK" in preparation. QTH's are inserted as they are received, up to the limit of the space allowance each month. Please write clearly and address on a separate slip to QTH Section.

- G3FMM**, C. H. Doley, 10 Apsley Grove, Dorridge, Solihull, Warks., B93 8QP. (Tel. Knowle 4398.) (Re-issue.)
- GM4ASY**, D. J. Yeaman, 5 Chartwell Road, Bishopton, Renfrewshire.
- G4AVT**, V. S. Evans, Beacon View, Parbold Hill, Lancs., WN8 7TG.
- G4BJT**, M. J. Ware, 45 Clothorn Road, Didsbury, Manchester, M20 0BP. (Tel. 061-445 6805.)
- G4BOS**, E. Bland, 15 Cecil Street, Lytham, Lytham St. Annes, Lancs., FY8 5NN. (Tel. Lytham 5790.)
- G4BPV**, P. R. Barker, 141 Falmouth Road, Redruth, Cornwall.
- G4BPW**, D. F. Reynolds (ex-G8DQY), 224 Station Road, Rolleston, Burton-on-Trent, Staffs. (Tel. Tutbury 3395.)
- G4BRM**, A. Long, 265 Henley Road, Coventry, Warks., CV2 1AW.
- G4BRU**, A. Lambe, Glenview, off Tresawls Road, Truro, Cornwall.
- G4BSC**, J. R. Wells, 96 Newhaven Road, Orford, Warrington, Lancs., WA2 0NS.
- G4BSF**, R. E. Small (ex-G8GHS), Corfe House, Corfe, Taunton, Somerset. (Tel. Blagdon Hill 230.)
- GI4BTG**, H. W. B. Davidson, 2 Ardeen Avenue, Newtonabbey, Co. Antrim, Northern Ireland.
- G4BTI**, D. A. Case, 165 Waterloo Road, Wokingham, Berks., RG11 2JN.
- G4BTW**, I. Jolly (ex-G8E00), Oakmere, 68 Liverpool Road, Chester. (Tel. 0244-29403.)
- GM4BTW**, I. Jolly, 2 Breadalbane Mews, Oban, Argyllshire.
- G4BUE**, C. Page, 25 Ashurst Avenue, Saltdean, Brighton, Sussex, BN2 FDR. (Tel. Brighton (0273) 31786.)
- G4BUS**, R. Prosser, Saitama, Main Road, Little Oakley, Harwich, Essex. (Tel. Ramsey 428.)
- GW4BVJ**, R. S. Mortimore, 20 Windermere Avenue, Cardiff, CF2 5PQ. (Tel. Cardiff 754588.)
- G8GEJ**, D. A. Poole, 23 Russet Road, Cheltenham, Glos., GL5 17LN.
- G8GFE**, G. N. Whitehead, Orchard Lodge, Gretton, Cheltenham, Glos.
- G8GMB**, S. H. Bradshaw, 82 Ardenway, Market Harborough, Leics.
- G8GNH**, M. Stanton, Sweetbourne Cottage, Hastings Road, Lamberhurst, Tunbridge Wells, Kent.
- G8GWH**, P. Marshall, 26 Birdbrook Road, Kingsdown, Swindon, Wilts., SN2 6RY.
- G8GXE**, A. J. Collett, Stag End, Farthing Green Lane, Stoke Poges, Bucks.
- G8GYD**, C. D. Appleton, 249 Devonshire Road, Atherton, Manchester, Lancs., M29 9QB. (Tel. 052-34 4452.)
- G8GYN**, A. Blair, 1 William Street, Chopwell, Newcastle-upon-Tyne, NE17 7JH.
- G8GYO**, P. B. Hilton, Kinburn, Rocky Lane, Heswall, Wirral, Cheshire, L60 0BZ. (Tel. 051-342 6971.)
- G8GYR**, J. A. Cass, 44 Dwarf Road, Wellingore, Lincs.
- G8GZQ**, M. A. Deacon, Pinebank, 2 Nanhill Drive, Woodhouse Eaves, Leics.
- GI8GZS**, I. A. Kernohan, 33 Tower View Avenue, Bangor, Co. Down.
- G8HAD**, J. Horsley, 65 Anthony's Avenue, Lilliput, Poole, Dorset, BH14 8JJ.
- G8HAE**, D. Johnson, 3 Ethelstone Road, Grimsby, Lincs., DN34 4EF. (Tel. Grimsby 55354.)
- G8HBA**, R. W. Hammond, 30 Harvard Road, Lewisham, London, SE13 6SF.
- GM8HDB**, J. N. Hatley, 10 Crags Road, Paisley, Renfrewshire.
- G8HDF**, D. V. Goble, 43 Daniel Close, Lancing, Sussex.
- G8HDG**, H. C. Goble, 43 Daniel Close, Lancing, Sussex.
- CHANGE OF ADDRESS**
- G3BTA**, A. R. Hamilton, 318 Chichester Road, North Bersted, Bognor Regis, Sussex.
- G3CDC**, C. S. Harrison, Fosse Ridge, Doverbeck Drive, Shelt Hill, Woodborough, Nots., NG14 6ER. (Tel. Woodborough 3361.)
- G3DAH**, A. H. Dormer, Dalkeith, 43 Mickleburgh Avenue, Herne Bay, Kent, CT6 6HA (Tel: Herne Bay 4558)
- G3JKR**, K. S. J. Rancombe, 6 Park Drive, Rustington, Sussex, BN16 3DZ.
- G3KWW**, R. W. Wilkinson, Lower Stonehams, Pangbourne Hill, Reading, Berks.
- G3NYK**, A. J. Melia, 67-A Deben Avenue, Martlesham Heath, Ipswich, Suffolk, IP5 7QR.
- G3PFE**, G. W. Spriggs, 22 Park Avenue, Sleaford, Lincs.
- G3REL**, B. W. Woodfield, 49 Oakfield Road, Hawley, Camberley, Surrey.
- G3RHU**, M. F. Stanbridge, 12 Hancock Close, Leiston, Suffolk.
- G3SCD**, D. B. Dunn, Millstones, Scamblesby, Louth, Lincs, LN11 9XG.
- G3SGX**, R. E. Bona, 54 Somerset Way, Richings Park, Iver, Bucks. (Tel. Iver 1665.)
- GW3UIY**, W. J. Williams, 11 Penybryn, Bryn, Llanelli, Carmar.
- G3VWL**, R. E. Kemp, 21 Orme Road, Worthing, Sussex.
- G4ANC**, J. E. Hills (VK2AJH), 168 Plateau Road, Avalon, N.S.W.—2107, Australia.
- GI4ANX**, A. B. R. Tuff, 16 Glenwell Crescent, Glengormley, Newtonabbey, Co. Antrim, Northern Ireland.
- G5UK**, M. B. Buckwell, 31 The Ridgeway, Westcliff-on-Sea, Essex, SS0 8NS. (Tel. 0702-76900.)
- GW8CGH**, D. C. Pickering, 26 Heol Ganol, Sarn, Bridgend, Glam.
- G8CRI**, B. K. Middleton, 11 Chiltern Road, Brant Road, Lincoln.
- G8GSF**, J. Sleeman, No. 24, 11th Row, Ashington, Northumberland, NE63 8QQ.
- AMENDMENT**
- GW3RXD**, G. Llewelyn, Bayano, 33 Awelfryn, Amlwch, Anglesey.

**TRANSISTOR DATA
The INTERNATIONAL TRANSISTOR
DATA MANUAL**

1973 Edition is now ready. Data on upwards of 18,000 transistors of International origin and other valuable information. £5.25 + 35p post and packing in U.K. £6.10 + 95p overseas.

Brochure available. Order direct from

**SEMICON INDEXES LTD.,
Freeport, Wokingham, Berks., RG11 1BR**

MORSE MADE !!! EASY !!!

FACT NOT FICTION. If you start **RIGHT** you will be reading amateur and commercial Morse within a month. (Normal progress to be expected.)

Using scientifically prepared 3-speed records you automatically learn to recognise the code RHYTHM without translating. You can't help it, it's as easy as learning a tune. 18-W.P.M. in 4 weeks guaranteed. For Complete Course 3 Records & Books send £4.50 (overseas £1 Extra).

For Further details of course Ring 01-660 2896/01-668 3255 or send 4p stamp for explanatory booklet to:—
G3HSC (Box 14) 45 GREEN LANE, PURLEY, SURREY

SMALL ADVERTISEMENTS

("SITUATIONS" AND "TRADE")

6p per word, minimum charge £1.00. No series discount. All charges payable with order. Insertions of radio interest only accepted. Add 50% for Bold Face (Heavy Type). Box Numbers 15p extra. No responsibility accepted for transcription errors. Replies to Box Numbers should be addressed to The Short Wave Magazine, 55 Victoria Street, London, SW1H 0HF.

TRADE

RTTY: Teleprinter rolls, 3½-in. diameter, parcel of six, £2 incl. postage.—**Warner, Brockton, Newport, Shropshire.** (Tel: Lilleshall 382).

QSL Cards for Tx and SWL. Send s.a.e. for samples stating which type required.—**Beaumont, G5YV, 8 Ashfield Avenue, Morley, Leeds, LS27-0QD.**

QSL CARDS and G.P.O. approved Logs (hard back), prompt delivery. Send 4p stamp for samples.—**Atkinson Bros., Printers, Looe, Cornwall, PL13-1JT.**

YORK Photo-Audio Centre offer the following Yaesu Equipment at reduced prices, these items having been used for showroom display only and sold as unused with guarantee: FT-101, £225; FT-560, £176; FT-75 £90; FR-400, £108. FL-2000B, £134. Also a few second-hand receivers and transmitters available; our up-to-date list by return. Your camera equipment taken in Part Exchange—and we also accept communications equipment in exchange for Cameras and Hi-Fi gear.—**51 Fossgate, York (56176), or 25798 after hours.**

MAY Issue: Due out April 27. Single-copy orders 30p, post free, to reach us by Wednesday, April 25, for posting on April 26.—**Circulation Dept., Short Wave Magazine Ltd., 55 Victoria Street, London, SW1H-0HF.**

THOUSANDS of Radio Bargains: Transmitters, receivers, relays, motors, meters, components, test equipment, valves, etc., etc. Send s.a.e. with enquiries.—**Auto Traction, 27A Arragon Road, Twickenham, Middlesex. (Tel: 01-892 9489).**

QSL Cards: For Tx, G8/3 and SWL, one to 4-colour designs; good selection; large s.a.e. for samples.—**Printon Printers (R/Rose), 105 Fleetwood Street, Preston, Lancs.**

S-METERS suitable for R.C.A. AR88 D/LF receivers, 2½-in. diameter, 5 mA full-scale deflection, right-hand zero, complete with detailed fitting instructions, price £4.75 each, post paid. Also available, spares for AR88 D/LF receivers, send s.a.e. for list.—**A. J. Reynolds, 5 Headland Way, Lingfield, Surrey.**

WALKIE-TALKIE: No. 88 ex-W.D. 14-valve four channel transmitter/receiver unit, £5, post/packing 62p. **No. 19 Sets,** ex-W.D. used transceiver valved unit, only £5, carriage £1. **Salvage** telemeter unit, multi-valve receiver, speaker and tape unit, sealed cartons, cost vast money, £3.75, carriage 75p. **Surplus** telephone hand-sets, 97½p, post/packing 17½p. **Ex-W.D.** tank aerials, 4-ft. top sections, three for 75p, post/packing 25p. **Switched ex-W.D.** unused moving-coil 19 Set microphone and headphone sets, at £2.50, p/p 25p. Unused **American ex-W.D.** quality feather-weight low-resistance headphones, £1.50, p/p 13p. **Auto-transformers.** unused. 240v. to 110v. at 75 watts, £1.25, p/p 25p. **Staff car** aerials, 87½p, post 12½p. **Counters,** four-figure, 2,300 ohm, £1.25, p/p 12½p. **Headphones,** 4 x 1 x 1-in., moving-coil low-resistance ex-W.D., padded and unused, £1.25, post/packing 25p. **Speech** recorders, Remington salvage, valved, for AC mains, cost vast amount, £5, carriage 75p. **Chart Board,** ex-W.D. A.M. type, for air speed, wind speed and distance, vernier calibration, in original cartons, cost vast money, £5.25, post/packing 75p. Callers welcome.—**Southern Surplus Merchants, Ltd., 66 London Road, Kingston-upon-Thames, Surrey. (Tel: 01-546 9263).**

UHF High-Pass Filters: Suitable for fitting in UHF/TV antenna lead. In many cases these have proved successful in eliminating TVI. Price £1.92 each. **E. & E. Services, 72 Elmstone Road, Rainham, Kent.**

READERS ADVERTISEMENTS

3p per word, minimum charge 50p payable with order. Add 25% for Bold Face (Heavy Type). Please write clearly, using full punctuation and recognised abbreviations. No responsibility accepted for transcription errors. Box Numbers 15p extra. Replies to Box Numbers should be addressed to The Short Wave Magazine, 55 Victoria Street, London, SW1H 0HF.

READERS

SALE: Philips PCR-3 receiver, with BFO, PSU, ANL and internal speaker, ideal for beginner, £10.—**Shaw, 16 Deansfield, Four Spires, Cricklade, Wilts.**

FOR SALE: Grundig 625-line TV camera, all solid-state, German manual and circuit, not commercially used and as new, £35; G.E.C. 17-in. monitor, all solid-state, as new but faulty, £15.—**Martin, 114 Briggs Fold Road, Egerton, Bolton (57775), Lancs.**

SELLING: HRO-5M, excellent condition and performance, miniature valves, ten coilpacks, including 20m. bands, PSU and speaker, £25 or near offer.—**Blenard, 21 Meadowbank Avenue, Allerton, Bradford (491523), Yorks. BD15 7BP.**

SPECIAL HRO RECEIVERS!

HRO. Tested and working, including a coil unit of our choice, **£18.**

HRO-5T. Tested and working, including a coil unit of our choice, **£25.**

State preferences for coils required.

LF coils **£1.50** each, 4 for **£5.**

HF coils **£2** each, 5 for **£9.**

Set of 9 coils for **£13**, if with receiver.

Power units at **£4** and **£5.**

Complete HRO set, **£32.**

Complete HRO-5T set, **£38.50.**

RI475. 2-20 MHz. Ideal tuneable IF, only **£11.**

Brand new power units to match, 240v. A.C. and 12v. D.C. inputs, **£5.50** with receiver, otherwise, **£7** (very few.) Some rough sets available, as spares only, **£6.**

Specialist Services

Distributors of all Sonax and Teleradio kits.

Kits supplied for any published article; send for details. If it is electronic, we will try to supply it. Try us first because we try harder, no enquiry too small.

Send large s.a.e. for full lists.

All communications acknowledged by return.

Post and packing free except where stated.

10% Value Added Tax must be added to all orders received after April 1, 1973

STUDIO ELECTRONICS (G8AIP)

P.O. BOX No. 18, HARLOW, ESSEX, CM18-6SH
Tel. Harlow 25457. Callers welcome by appointment

NEW! FOR TVI SUFFERERS HP1A FILTER

★ A high pass filter for UHF TV Receivers. The filter is ideal for combating TVI in UHF TV receivers from both HF and VHF transmissions. The filter takes care of RF currents on both inner and outer conductors of the TV aerial down lead. Filters are completely sealed. Just plug into rear of TV receiver. Price **£1.32** including V.A.T plus 10p P.P.

FERRITE RINGS. We are temporarily out of stock but should have a fresh supply by mid April at **18p** each. (5p P.P. any quantity).

ANTENNAS. MINI PRODUCTS. Miniature triband beams for the smallest of gardens.

Turning radius 6ft. Power rating 1500 watts. 10-15-20 metres. Send s.a.e. for details.

WIGHTRAPS for 5 band dipole, **£3.68** paid (20p)

Sole distributors for above products:—

WATERS ELECTRONICS (G3OJV)

8, GAY BOWERS, HOCKLEY, ESSEX.

Callers by appointment

Evenings Tel. 4930

RADIO COMMUNICATION HANDBOOK

Fourth Edition of the
Original RSGB "Amateur Radio Handbook"

Price **£4.10**

(inclusive of post and packing)

Available from stock

Order from

**PUBLICATIONS DEPT.
SHORT WAVE MAGAZINE LTD.,
55 VICTORIA STREET, LONDON, SW1H 0HF**

SELLING: Heathkit Mohican and mains unit, working but badly misaligned, with manuals **£12.50.** Buyer collects for cash.—Short, 49 Shaw Road, Dudley (52563), Worcs., DY2 8TP.

SALE: Trio 9R-59 receiver, coverage 0.5-30 MHz, very good condition, **£20.**—Wenlock, G3UNZ, 48 Newhall Street, Cannock, Staffs.

SALE: Eddystone 750 (see "Short Wave Magazine," May 1969), with speaker, manual, spare valves, in good condition, **£36.** Prefer buyer collects, or pays carriage. WANTED: Two 813's and bases.—Moon, G3YAX, QTHR. (Tel: Warrington 37138).

FOR SALE: DX-100U Tx, **£30;** AR88LF, **£30;** HRO Rx, **£15** or near offer. Carriage extra.—Bushell, GW3OSV, Park East, Clarboston Road, Pems., West Wales.

SELLING: KW-2000B, complete with AC/PSU, nice condition, **£150.**—Hurst, 31 Avondale Road, Fleet (5831), Hants.

SALE: No. 46 Sets, Tx/Rx, coverage 3-9 MHz, brand new in maker's carton, complete with carrying case, headphones, mic., and aerial, **£11** each or **£20** a pair. Two-metre FET pre-amps run in cascode for low noise and high gain, built in aluminium case 3-in. by 2-in. by 1-in., 9/12v. negative earth, 12 dB gain, **£2.50.** Two-metre FET converters, conversion gain of 18 dB. 28-30 MHz IF only, 9/12v. negative earth. **£8;** MW to Top Band converters, ideal for mobile, **£2.50.** Tx's and Rx's built to instructions at reasonable cost. All prices include carriage.—Godwin, 10 Windmill Hill, Saltash, Cornwall.

SALE: Redifon R.50M marine receiver, coverage 13 kHz to 32 MHz in eight bands, with speaker and PSU. **£80** or near offer.—Stott, 241 Holyhead Road, Coventry (593216), Warks.

FOR SALE: Complete amateur television camera and units, comprising: Marconi 405/525/625 commercial TV studio equipment, at present in use, with shift supply, scan generator, picture monitor, waveform 'scope monitor, control panel, video amplifier, gamma match, two power supplies, camera with complete duplicate spare units and one SPG, can be seen working anytime, first offer of **£100** secures. Requires 10 cwt. van to collect.—Jones, G5ZT-G6ABC/T, QTHR. Tel: 0752 776552 (Plymouth).

WANTED: Small automatic rotator; also oscilloscope, suitable as tuning indicator, only.—Coldwell, 172 Bradway Road, Sheffield, Yorks., S17 4QX.

SELLING: KW-2000 with AC/DC PSU, very good condition, **£120;** Pve Base Tx with '640 PA, modified, working on 2m., **£25;** two-metre transistor converter, IF 4-6 MHz. **£5.** Can deliver reasonable distance.—Cator, G4AED, 72 Vicarage Walk, Watton, Thetford, Norfolk.

WANTED: Koln E-52B receiver and/or spare parts, units, valves. (N. Ireland).—Box No. 5129, Short Wave Magazine Ltd., 55 Victoria Street, London, SW1H-0HF.

FOR SALE: FL-2000B linear, perfect condition, **£115;** FT-2FB with AC/PSU, hardly used and as new, **£95;** Collins 312-B4 control unit, good condition, offers?—Kendrick, G3RDW, Long Drive, Roman Road, Little Aston, Sutton Coldfield, Warks.

SELLING: New K.W. Atlanta, separate VFO, perfect condition, only 5 hours' use (through illness), **£165;** Heathkit HW-12A 80m. transceiver, new, with mic., speaker, DC/PSU, 4 hours' mobile SWL use, factory aligned and tested, **£65.** Buyer to test and collect. Greater London area.—Sissons, 25 Southlands Grove, Bickley, Bromley, Kent. (Tel: 01-464 3646).

WANTED: B.2 transmitter/receiver, complete or sections thereof (transmitter, receiver, power pack).—Tee, G8UA, 33 Red Lees Road, Cliviger, Burnley, Lancs.

SELLING: KW-2000A DC/PSU, £25; Heath SB-610 scope, £33; K.W. Pepmeter, £6.—Thurlow, 25 Sandilands, Croydon, Surrey. (Tel: 01-654 2761).

SALE: Self-supporting mast, with nine 4-ft. sections, centre plates, pole and bolts, £30.—Skinner, 61 Dudley Road, Bedfont, Middx.

FOR SALE: KW-2000B with AC/PSU, perfect condition, £170; also DC/PSU and loading coils for G-Whip aerial, 160 and 40m.—Bates, G3DF, 99 Rodenhurst Road, London SW4. (Tel: 01-674 1881).

EXCHANGE: Pair of 28 MHz walkie-talkie transistor transceivers FOR home-built 2m. transistor transmitter gear, or W-H-Y?—Box No. 5130, Short Wave Magazine Ltd., 55 Victoria Street, London, SW1H-0HF.

WANTED: Trio 9R-59DS receiver, details and price please.—Taylor, 7 Long Meadows Drive, Lacey, Grimsby (71409), Lincs.

SELLING: RECEIVERS: Collins 51-J, coverage 0.5-30.5 MHz; Eddystone 770R, coverage 19-165 MHz; Converter, 36-1000 MHz. Silicon rectifiers, 1250v./1½ amp., 10p each; s.a.e. please.—Wright, 249 Sandy Lane, Hindley, Wigan (55948), Lancs.

SALE: UHF receiver, tunable front-end, with IF unit 1000 to 2600 MHz, and 2300 to 4450 MHz, £15, Avometer Model 7 test meter, £16.50.—Box No. 5128, Short Wave Magazine Ltd., 55 Victoria Street, London, SW1H-0HF.

WANTED: For SWL station at the "Star Short Wave Club," New Inn Hotel, Bramley Town Street, Bramley, Leeds 13, an Eddystone 888A receiver with speaker and S-meter, must be in mint condition, cash paid. Club meetings every Wednesday at 8 p.m., please call or write.—Leeman, G4BUU, 115 Ascot Drive, Seacroft, Leeds LS14 1HX, Yorkshire.

SALE: Creed 7B 'printer (80 + 80v.), £10. Teletype 15 'printer, with perforator, PSU, tools and manual, £20. Heathkit 10-12U 'scope, £15. AR-22 replacement motor, £2.—Quantrill, G3OPF, 10 Milford Avenue, Stony Stratford, Bucks.

CLEARING SHACK: Signal generator, No. 6 'Scope, Test Set Type 102, "Command" Tx and modulator, T.U.5B type tuners, RF-27 for 24 to 25 MHz, two-metre PA (metered), HRO coil packs, audio amplifiers, one-inch and 5-in. CRT, VR-97 with time-base, 3BP1, CRT for 339, and other items, all in good condition. Offers?—Ward, G3HBM, 7 Regent Street, Burnham-on-Sea (2152), Somerset.

EXCHANGE: AR88D, Trio 9R-59DS receivers and BC-221 frequency meter, all in good condition, FOR Eddystone 770R or W-H-Y VHF-wise?—Ring Bedford, Merthyr Tydfil 2786 (Glam., South Wales).

FOR SALE: R.C.A. HF sweep generator, with 115v. AC PSU, 5 to 70 MHz in three bands, £10. U.S.A. Bendix signal generator, 1-130A, 100 to 155 MHz, nice job, £10. Small oscilloscope, TS-34/AP, 110v. AC, in carrying case, £10. Valve tester, very clean, 110v. AC, £5. New 60-ft. telescopic tubular masts (U.S.A.), crated, £20. American Rx R361/GR, 230v. AC, coverage 225 to 400 MHz, xtal controlled, £16. Freq. meter BC-906D, £3. Diode test meters (1 mA f.s.d.) TS.268, in case, £1.25. PSU, 24v. AC, 24v. 36v. AC out, £1. PSU, 240v. AC, 12v. 2A AC out, £1. New 4CX250B's, £5. All plus carriage.—McCaig, GM3BQA, Woodlands, North Berwick, East Lothian, Scotland. (Tel: North Berwick 2519, after 7.0 p.m.).

Due to Warehouse Clearance we have a few low powered F.M. VHF Wireless Station Type A, A.F.V. No. 88. Contained in two units (1) Transmitter/Receiver, (2) 12 volt Power Unit and L.F. Amplifier. The Tx and Rx are contained in a waterproof diecast alloy case, using a total of 14 valves, operates on four switched channels which are Crystal controlled.

All 8 Crystals are supplied, and are the same in each set. Therefore all sets will transmit and receive to each other, provided each are switched to the same channel out of the four.

The Stations are supplied with mounting carriers, 2 vertical whip aerials, plus aerial base, spare valves, bulbs, mounting screws, connectors, etc. Including the operating manual giving all details, plus circuits of the wireless set.

All above items are individually boxed and wrapped, placed in original transit case.

ABSOLUTELY BRAND NEW—Made by Echo for the Government no expense spared, few only available at £9.50, carr. £2.

RADIO TELETYPE TERMINAL SET

A. type, AN/SGGIA latest Government release of these sought after units, housed in metal case, approx. size: 8" x 19" x 16" deep. Using a total of 11 valves, supply voltage: 115 volts 50 c/s. Containing Meter switched for checking, send and receive bias, send and receive level loop and plate current, in fair used ex-Government condition. Few only available at £7.50, carr. £1.50.

TRANSCIEVERS. Due to warehouse clearance we have for disposal, few only Transceivers No. 62 Mk. 2, made by Pye for the Navy and Army. Using a total of 11 valves, 1 RF and 2 I.F. stages, A.V.C., BFO, covering 1.5 Mc/s. to 10 Mc/s.



(approx. 200 to 30 metres) in two switched bands. Can be used on RT or CW M.O. or Crystal. A very good internal ATU made of a rotating silver wire coil, tunable over the complete range, suitable for aerials 4ft. to 100ft., internal P.U. for 12 volt D.C. A meter is fitted for checking voltages A.V.C., etc. Housed in a metal waterproof case, approx. size 18" x 10½" x 12½". Supplied in as new condition, being either re-built by Army Signals or store-soiled new set. In cartons two spare valves, circuit, price £17.50, carriage £2. Suitable hand telephone with spring coil plus transmitter switch in handle. Modern, £1.50.

CRYSTAL CALIBRATOR No. 10. Range 500 kc/s. to 10 Mc/s., up to 30 Mc/s. on Harmonics. Size: 7" x 7½" x 4". Power 300 volts HT, 12 volts LT. The Calibrator can plug into a Power Socket on the 62 Trans-Receiver which it was normally used with. Supplied in good used condition with circuit, £2.50, Post 50p or BRAND NEW IN CARTON, £5.00, 50p post.

LARGE QUANTITY OF TELEPRINTER PAPER Available, sprocket fed, contained in sealed packs, each pack containing 4 separate wads, price 60p per pack of four pads, post 25p, or wooden crate containing 5 packs equals 20 wads, £2, carr. 50p.

JOHNS RADIO

424 BRADFORD ROAD,
BATLEY, YORKS.

Phone: BATLEY 7732

SALE: Gonsett G-66B receiver, transistor PSU for 6/12v. or 115v. operation, £50. Heathkit DX-100U transmitter, £28.—Jones, G3PSZ, Millcombe Down, Northlew, Okehampton, Devon. (Tel: Hatherleigh 213).

SELLING: Panda "Cub" Tx, coverage 10 to 160 metres, new VFO, etc., as "Short Wave Magazine," price £12.50, buyer to collect.—Holloway, G2DGW, QTHR, or ring Waltham Cross (Herts.) 34275.

WANTED: Circuit or manual for Redifon R.50M receiver.—Fisher, 27 Malvern Road, Maidenhead, Berks., or ring Maidenhead 30068, evenings.

WANTED: KW-160, Codar A.T.5 or similar Top Band transmitter. Home-built or faulty unit considered.—Box No. 5132, Short Wave Magazine, Ltd., 55 Victoria Street, London, SW1H-0HF.

FOR SALE: Pye Ranger rig, consisting two mobiles and one fixed station, all working, price £20, buyer to collect.—Ring Pettitt, 01-590 3618 (Romford, Essex).

MAY Issue Short Wave Magazine due out on Friday, April 27. Single copies at 30p post free can be supplied to orders reaching us by Wednesday 25th, for despatch on Thursday 26th, the day before publication. These copies go out flat in an envelope, first-class posting. Orders with remittance to:—Circulation Dept., Short Wave Magazine, Ltd., 55 Victoria Street, London, SW1H-0HF.

SALE: K.W. 52-ohm dummy load, unused, £5; K.W. Ezee-Match, £3; Codar PR-30X preselector, £6; 19 Set variometer, £1; K.W. Atlanta, ten months old, little used as standby equipment, £160.—Caw, G4ALV, QTHR. (Tel: 01-460 3852).

FOR SALE: Eddystone EC-10 Mk. I receiver, good condition, £30. Buyer collects.—Ring Collier, 021-422 5196 (Birmingham), evenings.

WANTED: Ex-R.A.F. T.1154 transmitters, models K, H and M only; equipment less meters and valves acceptable. £10 offered, and £2 towards carriage. (Co. Durham).—Box No. 5131, Short Wave Magazine Ltd., 55 Victoria Street, London, SW1H-0HF.

FOR SALE: Brand new transistors: BCY-31, 20p; OC-84, 17½p; OC-139, 17½p; OC-200, 20p; postage and packing, 5p.—Page, G3KWC, QTHR. (Tel: Stamford 4012).

SELLING: BC-221 complete with charts, £18; RA-1 Rx, without case, £10; "Cannonball" SSB exciter, £15. Also PA valves and junk. Will haggle.—Ring Rees, G3SRR, 01-573 4951.

SELLING: Heathkit DX-100U with manual, £35; Codar A.T.5 with 250 M/S mains PSU and home-built 12v. PSU, £20. Can deliver up to 50 miles.—Field, G3XTT, QTHR.

SALE: Eddystone S.750 receiver in good condition, £40 or near offer; Trio TR-2200 Tx/Rx, FM 6 channel, £50 or near offer.—Kemp, G8CWZ, 28 Croft Avenue, Richmond, Yorks.

SALE: New Trio 599 "Special" communications receiver, owner going abroad, used one hour only (cost £185), bargain at £145.—Ring Howard, 01-693 8775 (after 6.30 p.m., Mon-Fri.).

OFFERING: Pye "Cambridge," six channels, also Pye base station. Both in good condition and with crystals for 70-26 MHz. Offers, please?—Burgess, G3VPT, QTHR. (Tel: Norwich 898715).

SELLING: Nos. 19 and 52 Sets, both with PSU, £9.—Small, 23 Butts Way, Norton Canes, Cannock, Staffs. (Tel: Heath Hayes 79367).

OFFERING: Labgear LG-300 transmitter, complete. Property of late G3NY. Offers invited.—Snowden, Swainsea Lane, Pickering, Yorks.

SELLING: Heath DX-60B transmitter complete with HG-10B all-band VFO and ceramic mic., all in excellent condition, £50.—Corper, G3ZQJ, 60 John Wilson Street, Woolwich, London, S.E.18.

SALE: Mosley Mustang three-element beam, fibre-glass protective coating, assembled but unused, £30.—Fell, G3LIQ, QTHR. (Tel: 0482-500020, Hull).

SELLING: Heath SB-610 monitor 'scope, mint condition, £35; Home-built mobile PSU, suit HW-12, £10; home-built Codar A.T.5 with mobile PSU, £10.—Linney, G3VQL, QTHR. (Tel: Shrewsbury 51733).

OFFERING: New Lafayette five-band AM/CW/SSB communications receiver, with Trio speaker, £35 or near offer (list price £55).—Ring Waters, Stoke Fleming 447 (Devon).

FOR SALE: A few dash-mounted High-Band Rangers, modified for two metres, cases re-sprayed as new, without Tx and first oscillator crystals, complete with mic. and cradle, £7 each. Carriage 75p.—Burgess, G3VPT, QTHR.

SALE: Skywood communications receiver, as new, boxed, £18 or near offer.—Fife, 65 Fountainhall Road, Edinburgh. (Tel: 031-667 3540).

SELLING: Pye AM-10B/V Cambridge, high-band, clean condition, working, ideal for conversion to two metres, less accessories, £16. One six-channel set, £18.50. Carriage paid.—Ring Jackson, 061-792 1214, ext. 21. (Manchester).

SALE: Yaesu Musen FR-DX400 receiver, with 100/25 kHz calibrator, absolutely mint, little used, £95; Hamgear 160m. converter (converts from 7 MHz), brand new, £7; Collins mechanical filter Type F.455Z1, 2.7 kHz bandwidth, £8.—Hough, G3XTN, 55 Fishponds Road, Kenilworth (56828), Warks., CV8 1EY.

WANTED: For RTTY: Terminal unit ATM type FSY.1.1 (AP.10038) and PSU, or similar type terminal unit.—Lumb, 4 Rydall Street, Leeds LS11 9LF.

EXCHANGE: KW-202 with speaker, calibrator and manual, 8 months old FOR Hammarlund HQ-180A or HQ-170A. Must be in good condition.—Ring Gower, 01-595 6792 after 6 p.m.

WANTED: Pye Pioneer service manual, buy or borrow.—Reiss, 34 Nursery Lane, Moortown, Leeds, 17. (Tel: 0532 683884, evenings).

SELLING: Swan 350 transceiver with PSU and VFO-410, £140; HRO-500 solid-state communications receiver, coverage 5 kHz to 30 MHz, £350.—Ring Gale, 01-998 2337.

FOR SALE: FR-100B, good condition, excellent performance, £70; BC-639A with matching PSU, 100-155 MHz, £15. Buyers collect. Emsac receiver ATU, as new, £4 post paid.—Burton, 159 Redworth Road, Shildon, Co. Durham.

SALE: Hammarlund SP-400X communications receiver, coverage 1.25-40 MHz, £39; TF-144G, £12; TF-948, 20-80 MHz, AM/FM, £12; TF-885 video oscillator, £19; 1000 pF disc ceramic capacitors, 25 for 45p.—Whitbread, G8AYN, QTHR. (Tel: Crayford 24625).

SELLING: KW-2000B with AC/PSU, manual and Shure 201 mic., 8 months old, little used, £170.—Stenhouse, G3MAY, QTHR, or ring 01-808 0197.

CLEARING WORKSHOP: 60-watt CW transmitter, built-in PSU, £8; 150-watt amplifier, £4; 19 Set, £6; PSU for 19 Set, £4; Avo valve voltmeter, Type CT-38, £15; Collector's item: 1929 (approx.) Osram "Melody Master," offers? Other items. s.a.e. please.—Caid, 24 Hill Street, Tillicoultry, Scotland.

SELLING: National NCX-5 Mk. II with NCX/A PSU, as new, £175; Solartron D-300 scope with service manual, £17.50; Pye PTC-2007, Tx working on 144.30 MHz, tunable Rx, 15-watt AM with mic., £10; 4m. mobile transceiver, 3-channel Tx, tunable Rx, 10-watt AM, with T-17 mic. and separate PSU, £15. All "or near offer."—Moxey, G3MOE, 11 Westbury Road, Cheltenham (0242-24217), Glos.

SALE: KW-2000A with AC/PSU, handbook, mic., spare valves, SWR bridge, RF indicator, good condition, £165 or near offer.—Leach, G4AMZ, 27 Grosvenor Road, Heaton Moor, Stockport, Cheshire.

SELL OR EXCHANGE: R.209 Mk. II Rx, 12v. DC, all amateur bands, good condition, £8.50 carriage extra. Call or write.—Page, 20 Allen Street, Maidstone, Kent.

SELLING: Unmarked 898 dial, £4.50; Joystick and 3A tuner, £8.50. Rotary coil, 50p; Sinclair Q.16 hi-fi speaker, 8-ohms, £6; Eddystone power pack, 6v. to 250v. at 85 mA., £3; Offers invited for 1968 to 1972 RSGB "Bulletins" and approx. 50 copies "Short Wave Magazine."—Garlick, 135 Rookhill Road, Pontefract, Yorkshire.

FOR SALE: Heathkit HW-17A 2m. transceiver and HW-17-1 mobile PSU and HWA-17-2 FM adaptor, with 5 crystals and handbooks, £60; Pye AM-10D Cambridge High-Band, as new, £30; U.S.A. VHF Rx Type R2/ARR3, 13-valve superhet., £6; DL6SW converter, IF 28-30 MHz, £6; Cavity Wavemeter Type TS-184A for 70 cm., with PSU and manual, as new, £7; Heathkit Apache Tx, 80-10m., with SB-10/U SSB adaptor, no mods., with manual, £55; Rx/Tx Type RT/34/APS13, for 70cm., £3; Digital adding machine, 9-face readout, working and modern, £20. And some two-metre items, s.a.e. for details.—Sheedy, G8EWO, 24 Thornwood Road, London, SE13 5RG.

SALE: Murphy 960D VHF Tx/Rx, dash-mounted, AM, 12-watt output, partly transistorised, very clean condition, £12; Murphy 320 VHF Tx/Rx, dash-mounted, AM, 6-watt output, good condition, transistorised PSU, £8; Murphy 801A VHF Tx/Rx, dash-mounted, 6-watt output, vibrator PSU, £6; Murphy 801A less PSU, £4.50; all complete with battery leads and mics., suitable for conversion to 2 or 4 metres. Murphy base station, Low-Band, AM, 320A final, with mic., £15; Cambridge AM-10B Low-Band, complete with control box, mic., speaker and cables, very clean, £22; ditto High-Band, £25; Cambridge mounting brackets for dash or boot models, £1. Carriage extra.—Dickson, GM3DIE, 91 Milton Road West, Edinburgh 15. (Tel: 031-669 1416, after 6 p.m.).

SELL OR EXCHANGE: Lafayette HA-600 receiver, little used and in good condition, £30 or PART EXCHANGE for JR-310.—Ring Longshawe, Banbury 4218, office hours.

SALE: Telford Communications TC-7, tunable IF 28-30 MHz, with matching two-metre converter, recently overhauled, £33 or near offer.—McCartney, 1 Lockhart Place, Hawick, Roxburghshire, Scotland.

FOR SALE: Hallcrafters SX-16 receiver, coverage 550 kHz to 61 MHz, with xtal filter, BFO, etc., spare valves and handbook, £15. Two-metre valve converter and pre-amp, IF 4.6 MHz, £6. Bantex 2m. $\frac{3}{8}$ -wave whip aerial, £2.—Taylor, 30 Cavendish Way, Mickleover, Derby.

FOR SALE: Service Sheets, 1946 to '56 era, about 2,500 in all from "Trader," "Trading," "Radio Retailer" and manufacturers, in spring back binders with Newnes 1952 Manual, £40 or near offer. Also 100 obsolete valves, 1946-'56, 2v., 4v., 6v. and "universal" types, new and unused, 10p each. Buyers to collect.—Bingham, 9 Beechwood Avenue, Tilehurst, Reading, Berks., RG3 5BJ. (Tel: Reading 28494).

THE RADIO SHOP 16 CHERRY LANE, BRISTOL, BS1 3NG
Telephone: Bristol 421196. STD Code 0272
Your West Country shop for electronic components and solid state devices

2 METRE CONVERTER KIT. 9-12v. Neg. earth feeding 28-30 MHz. Consisting of: RF BF180, Fet. mixer, crystal osc., BF180 and multiplier BF180. Complete with all components, instructions and aluminium box. Not for beginners. £6.00, post paid

2 METRE PRE-AMPLIFIER. Single F.E.T. Pre-amp, neg. earth. Gain app. 12 dB. Circuit, instructions and components. All you need is a tobacco tin. £1.40, post paid

Prices include VAT. (TRIO STOCKISTS) Catalogue 6p, post paid

SELL OR EXCHANGE: Four-metre converter of Yaesu Musen type (offers?), FOR 70 cm. converter, IF out on 2 metres.—Stilley, 46 Kingfisher Avenue, Ipswich (58372), Suffolk.

QRT Sale: Heathkit HW-100 and HP-23 AC/PSU, in mint condition, £120.—Cunningham, G3PBW, 30 Manor Farm Crescent, Stafford.

SELLING: Kokusai MF-455-15CK filter with data; S-meter 2½-in. square; small speaker. All new, £10 the lot.—Ring Greenslade, Cufley 2948 (Herts.).

FOR SALE: USSR call area and zone lists, useful for DX'ers. Each 8p (P.O. and large s.a.e.).—Underwood, G3VDW, QTHR.

SALE: Heath GR-78 receiver, factory built, perfect condition, but not required, nearest £60. G.E.C. Miniscope, as new, with circuit, handbook and case, with spare unit and case, price £12 or offer.—Send s.a.e. or ring Medway 31772, Briscoe, 5 Marshall Road, Rainham, Kent, ME8 OAR.

SPARES for Creed Types 7, 8 and 85. All types. Also terminal units, 4X150's and sockets.—Brown, G3LPB, 1 Silverdale Road, Falmouth, Cornwall.

SELLING: CR-100 receiver with S-meter, in good condition, £10 or offer. Also two-metre FET converter, £1.50. Ring Dix, Potters Bar 56735 (Herts.).

OFFERING: Collins KWM-2, very little used, as new and in mint condition, with AC/PSU 516F-2, PM-2 portable PSU, mobile PSU MP-1 and mobile mount, with noise blanker, antenna and manuals, today's price over £1,500. Also mint Collins 51S-1 with 55G-1 tuner and manuals. For those who want only the best equipment. Sensible offers, and letter first, please.—Box No. 5133, Short Wave Magazine, Ltd., 55 Victoria Street, London, SW1H-0HF.

FOR SALE: Heathkit DX-40U with VFO, £18. Codar PR-30X preselector, £4. Pair "Callbooks," DX and U.S. listings, £2.50.—Torrance, G8HDZ, 4 Penpool Lane, Welling, Kent.

WANTED: BC-221 frequency meter, with PSU, in good condition.—Taylor, 4 Larch Road, R.A.F. Topcliffe, Thirsk, Yorkshire.

SALE: Eddystone 940, plinth speaker, perfect condition, price £85, or £80 if buyer collects.—Long, 9 Burlington Grove, Barnstaple (3432), North Devon.

SELLING: Heathkit DX-100U transmitter, AM/CW, with construction manual, £26. Pair "Cotswold" speakers, £35. GKD "Chiltern" hi-fi equipment cabinet, £25.—Ring Tackley, G3BRQ, Fleet 6588 (Hants.).

FOR SALE: Eddystone 770R receiver, VHF coverage 19 to 165 MHz, modes AM/CW/FM/NBFM, with muting, in oyster finish, recently overhauled to manufacturers' specification, £120 or nearest. Also "Record" pen recorder, 1 mA drive, speeds 6 to 12-in. per minute, sync. motor, price £30 or offer.—Ring Pratt, G3MHS, Sedgley (Worcs.) 73465.

SALE: R.C.A. AR88LF receiver, with S-meter, RF/IF/AF gain controls, selectivity variable from 70 kHz to 500 kHz, coverage 1.2 to 30 MHz, finish panel light blue in grey cabinet, in extremely good condition, best offer over £40. Also AVO RF signal generator, covering 9 kHz to 85 MHz, with circuit diagram, "a good runner," £12.—Ring Evans, Harpenden (Herts.) 61265.

OFFERING: Lafayette HA-600A receiver, with speaker and stereo headphones, cash sale £30 or offer? Could deliver within 15 miles Ilford, Essex.—Ring 01-478 0173.

FOR SALE: J-Beam two-metre crossed dipole antenna, Type 2/XD, brand new and unused, £3.75 post paid. Also Creed 7E teleprinter, with AC motor, in good order, £20. Delivery by arrangement.—Michaelson, G3RDG, QTHR or ring 01-455 8831.

SELLING: Trio TS-510 transceiver, as new, all extras and including some spares, £140. Also the FL-1000 linear amplifier, with spare valves, £70. Buyers to collect, or carriage extra by arrangement. (H.P. available on both these items). And a Hamgear PM-II preselector, £5.—Jones, GW3TMP, QTHR.

SALE: Marconi VHF Signal Generator, Type TF-1064B, frequency coverage 68 MHz to 470 MHz in three ranges, giving RF, IF and AF signal generator sources, cost £350, suggesting offers for this instrument between £50 and £100.—Ring Evans, Harpenden (Herts.) 61265.

FOR SALE: Joystick and Joymatch III, cost £23, never used, price £13.—Ferguson, 16 Erracht Road, Inverness, Scotland.

WANTED: Power Supply Type 697 for National HRO receiver. Power plugs for the B.2. Also an Eddystone 6-pin coil base.—Carter, G2NJ, 34 West Parade, Peterborough.

OFFERS For Collins 62S-1 with cables, manual, spare 4X150A, in mint condition, very little used, owing to owner having only limited time available. Cash offers invited.—Box No. 5134, Short Wave Magazine, Ltd., 55 Victoria Street, London, SW1H-0HF.

SALES AND SERVICE FOR ALL THE KW RANGE
New equipment from stock. All repairs guaranteed.
S.H. offers:

- 2000B in mint condition £175
 - Eddystone 940 P/Spkr. Immac. £100
- Demonstrations by Appointment.

TELECOMMUNICATION SERVICES

137 HAVEN LANE, MOORSIDE,
OLDHAM, LANCASHIRE

Telephone : 061-652 8617, 061-624 3448, 061-633 1206

SENSATIONAL HALF PRICE CLEARANCE
Almost
HURRY-ITS THE RADIO BARGAIN OF THE YEAR
BATTERY OR MAINS
AIRCRAFT/PUBLIC SERVICES MULTIBAND VHF RADIO RECEIVER
PREVIOUSLY SOLD AT £220
CLEARANCE PRICE £11.75
+25p P&P



GRAB THIS BARGAIN QUICK !! It was selling at £20 only a few months ago but we urgently need stock-room space must clear remaining stocks immediately. Look around—you won't find better radio value anywhere! Where else could you buy a genuine VHF Multiband Communications Receiver complete with built-in battery charger for under £12? It's the radio bargain of a lifetime! The best communications receiver around in this low price bracket and **REMEMBER**—these are **BRAND NEW** by famous manufacturer—in original presentation boxes. Make a really fabulous set for any communications enthusiast. As well as all the usual BBC (medium and VHF) Luxembourg and Continental Broadcasts, this specialised receiver picks up all aircraft transmissions (pilot to control tower etc) plus Pop Pirates, Taxis, Fire Brigades, Ambulances, even your local police! A complete home entertainment centre day and night. Hundreds and hundreds of exciting and unusual broadcasts. **THE FABULOUS SPECIFICATIONS INCLUDE**—Tuning Control, Waveband Selector Switch, On/Off/Volume, Control, Battery or Mains operated, Built-in ferrite rod aerial + external telescopic antenna for perfect VHF Reception, Battery Charger Indicator and Personal Earphone. **FREQUENCIES:** MEDIUM 540-1600 kcs.; FM/VHF 88-108 mcs.; AIRCRAFT 108-138 mcs.; PUBLIC SERVICES 145-174 mcs.; WEATHER BAND 162.55 mcs. Sizes 10 1/2" x 4" x 8 1/2". **WE SPECIALISE IN UNUSUAL FREQUENCY RADIOS AT PRICES FROM £7 to £75. WE MUST HAVE A MODEL AMONG THIS COMPREHENSIVE RANGE TO SUIT YOUR EXACT REQUIREMENTS.**
N.B.: THE MINISTRY OF POSTS & TELECOMMUNICATIONS HAS POINTED OUT THAT A LICENCE (NOT GENERALLY AVAILABLE TO THE PUBLIC) IS REQUIRED FOR RECEPTION OF TRANSMISSIONS BY FIRE BRIGADE, AIRCRAFT, SHIPPING, etc., BUT THERE IS NO LICENCE NEEDED TO BUY.

SCIENTIFIC & TECHNICAL (Dept.) TOWERFIELD TRADING ESTATE, SOUTHELD, ESSEX.
Callers: 507-511 LONDON ROAD, WESTCLIFF, ESSEX AND 186, TOTTENHAM COURT ROAD, LONDON W.1.

NOT JUST A RADIO BUT A COMPLETE COMMUNICATIONS RECEIVER
BATTERY/MAINS PORTABLE RECEIVER
WHAT RADIO PRICED AT UNDER £120 GIVES YOU SUCH A VARIED CHOICE OF TRANSMISSIONS?
8 WAVEBANDS The most exciting radio ever!
Picks up ALL THE USUAL BBC Programmes
*All the new local radio stations *Continental *World-wide transmissions *Pop Pirates *Radio Hams *Aircraft *Shipping *Police *Taxis *R.A.C. *A.A. *Fire Brigade *T.V. Sound *Ambulances and 1,000s more.
THE BEST PORTABLE RADIO EVER MADE! We think so. What radio priced at under £120 gives you such a varied choice of transmissions? As well as the standard long and medium wavebands it has three short wave bands (including the Marine and Trawler Band) **AND NO LESS THAN THREE V.H.F. BANDS**—truly a complete **WORLD-WIDE** communications Receiver. **JUST THINK!** one minute you can be listening to your favourite B.B.C. programme and then—at the flick of a switch—you can tune into the control tower and hear a "crippled airliner" being talked down to safety. Or listen to the trawlers and ocean-going liners—eavesdrop on the taxi-cabs, fire brigades, ambulances, A.A., R.A.C. and 100s of other R.T. mobiles—even your local police!! Extensive shortwave coverage can give you Australia, Pakistan, Luxembourg, North America, Far East, etc., etc., you name it—it gets it! Manufactured by one of the world's leading specialists in communications and TV equipment, each set carries a **FULL 3-YEAR WRITTEN GUARANTEE**. Beautifully finished in Teak Wood and Stainless Steel—will add distinction to any living-room. Completely portable 12" x 9" x 4", using standard batteries—or can be plugged directly into mains. **PLUS two external telescopic antennae**—with sockets for additional aeriels. Complete with beat frequency oscillator for the real enthusiast, or car aeriels. Automatic Drift-Free Reception. Tone control. Fine squelch control. Hi-Fidelity earphone for Private listening, local DX switch. **FREQUENCIES:** Long W 150-350 kcs. Medium W 540-1605 kcs. Marine 1.6-4 Mc/s. Short W 1.7-9 Mc/s. Short W 2.9-22 Mc/s. F.M. (VHF) 88-108 Mc/s. Aircraft (VHF) 108-138 Mc/s. Public Service (VHF) 148-174 Mc/s. **THE ULTIMATE** in communications receivers—used by professionals and amateur enthusiasts all over the world. **INSTANT CASH REFUND** if not overwhelmed by the superb tone, clarity and performance range.
Send 5p stamp for comprehensive Brochure of Unusual Frequency Radios.
CASH PRICE £49.50 +50p P & P or £14.50 dep. +50p P & P & 6 months at £7 (£56.50)



REG. WARD & CO. LTD. (G2BSW)

WE ARE OFFICIALLY APPOINTED K.W. AGENTS FOR THE SOUTH WEST (Somerset, Dorset, Devon, Cornwall)

KW Atlanta with p.s.u.	£210-00
Remote VFO	£37-00
KW 2000B with p.s.u.	£240-00
Remote VFO	£39-00
KW 2000E TCVR; & A.C. p.s.u.	£265-00
KW 202 Receiver	£140-00
Matching Speaker	£8-00
KW 204 Transmitter	£160-00
KW 1000 Linear	£135-00
KW 101 VSWR Meter (52 or 75 ohm)	£8-25
KW 103 VSWR Meter and Combined Power Meter	£12-50
KW E-Z Match, 10-80m. ATU	£16-50
KW 107 Combined E-Z Match, VSWR and R.F. Power Indicator, Dummy Load and Antenna Switch for 4 Outlets	£46-00
KW Trap Dipole 70' 75 ohm Twin Feeder	£15-00
KW Trap Dipole 97' Coaxial Feeder	£16-50
KW Trap Dipole with Balun	£18-50
KW 3 way Antenna Switches (for coax)	£4-25
YAESU	
FR50B Amateur Bands Receiver	£59-00
FT101 260w. Transceiver, with mic.; spkr. and built-in A.C./D.C. p.s.u.s.	£249-00
FR50 + Cal WWV	£63-00
FT200 Transceiver	£134-00
FR200 A.C. p.s.u.	£38-00
FR400SDX Rx. (with 160 and 2m.)	£160-00
SP400 Speaker	£10-00
Caston 24 Hour Digital Clocks	£7-50

EDDYSTONE RECEIVERS
EC10 Mk. II, £86; 8307, £372-75; New Model 1000, £210.
WE ARE THE DISTRIBUTORS OF EDDYSTONE PROFESSIONAL RECEIVERS FOR THE SOUTH WEST.

TRIO EQUIPMENT MODEL 9R59DS £49-50
SECOND HAND EQUIPMENT in stock: K.W. Atlanta Transceiver, £175; KW 202 RCVR with matching SPKR as new, £130-00; Eddystone 846 RCVR (G/coverage), £30-00; Trio 9R59 DS £39-50.

SHURE MICROPHONES
Model 444, £14-00; Model 201, £5-75; Model 202, £6-60.

ANTENNAE J-Beam 2 metre Beams in stock. Also Joystick and Joymatch A.T.U.'s, Stollie Ant. Rotators. 140ft. coils 14G. Copper Antenna Wire & Ribbed Insulators.

R.C.A. VALVES for KW and Heathkit equipment, 6146, 6146B, 6HF5, 6LQ6, 6GE5, 6EA8, 6GW8, 6GK6, 6CM6, 6CL6, 6CB6, 6BN8, 6HS6, 6EW6, 12BA6, 12BE6, 12B26, etc. and many other types.

TRADE INS WITH PLEASURE. OUR STOCK OF GOOD SECOND HAND EQUIPMENT CHANGES DAILY - LET US KNOW YOUR REQUIREMENTS.

Due to currency fluctuations prices of imported equipment are liable to alteration. Y.A.T. applies from April 1st.

WE STOCK R.S.G.B. PUBLICATIONS, LOG BOOKS, Etc.

HP TERMS AVAILABLE CARRIAGE EXTRA ON ALL ITEMS.

AXMINSTER - DEVON Telephone: 3163

BERNARD BOOKS

COIL DESIGN AND CONSTRUCTION MANUAL	35p post paid
HANDBOOK OF TESTED TRANSISTOR CIRCUITS	45p post paid
HOW TO MAKE AERIALS FOR T.V. (Band 1 & 3) AND V.H.F. (Band 2)	23p post paid
HIGH FIDELITY LOUDSPEAKER ENCLOSURES	45p post paid
RADIO & ELECTRONIC COLOUR CODES & DATA CHART	21p post paid
RADIO TELEVISION AND ELECTRONICS DATA BOOK	30p post paid
TRANSISTOR CIRCUITS MANUAL No. 1	21p post paid
HANDBOOK OF TRANSISTOR EQUIVALENTS & SUBSTITUTES	45p post paid
HANDBOOK OF RADIO, T.V., & INDUSTRIAL TUBE & VALVE EQUIVALENTS	45p post paid
SOUND & LOUDSPEAKER MANUAL (No. 8)	56p
WORLD'S SHORT WAVE MEDIUM & LONG WAVE RADIO STATIONS & FM & TV LISTING	41p post paid

Available from

SHORT WAVE MAGAZINE

Publications Dept., 55 Victoria Street, London, SW1H 0HF 01-222 5341/2
(Counter Service, 9.30-5.15, Mon. to Fri.)
(Nearest Station: St. James's Park)
(GIRO A/c. No. 547 6151)

DERWENT RADIO

5 COLUMBUS RAVINE, SCARBOROUGH. Tel. SCA 65996

Showroom open Tuesday/Thursday/Friday/Saturday

MEMBER OF THE AMATEUR RADIO RETAILERS ASSOCIATION

PLEASE ADD VAT TO ALL PRICES EXCEPT PUBLICATIONS

KW103 swr/power	£12-50	Trio 9R59DE	£49-00
KW 2000E and A.C. p.s.u.	£265-00	Trio SP 5D speaker	£4-50
KW Atlanta and p.s.u.	£210-00	Trio TS 515 transceiver	£210-00
KW 202 receiver	£140-00	Trio TX 599 transmitter	£185-00
KW 204 transmitter	£160-00	RCA IC manual	98p
KW 107 AE match unit	£46-00	RCA Hobbies manual	75p
KW EZ match	£15-00	RCA Valve manual	98p
KW 101 swr bridge	£8-25	RCA COS/MOS	98p
KW AE switch	£4-25	G Whip tribander	£10-50
KW Balun	£1-95	G Whip 160/80m.	£9-00
KW Atlanta VFO	£37-00	G Whip 160 Ranger	£7-50
Eddystone EC10 Mk. II	£28-00	G Whip base mount	£2-50
Eddystone EC10 A.C. p.s.u.	£7-75	G Whip LF coils	£4-00
Yaesu FT 401	£230-00	Lafayette HA 600	£50-00
Yaesu FT101	£255-00	Lafayette HA 800	£57-00
Yaesu FT200 and p.s.u.	£172-00	Codar CR70A receiver	£27-00
Yaesu FR400S	£160-00	Codar PR30X	£9-50
Yaesu FL400	£146-00	Codar 12 IRC cl. unit	£2-50
Yaesu FR50B	£59-00	Codar Multiband 6	£11-50
Yaesu FL50	£68-00	Wight traps standard	£2-75
Unica UR1A Rx	£25-00	Wight traps hi power	£3-75
Unica UNR30 Rx	£14-75	Shure 201 microphones	£5-50
Transistor Rx. with 2M TE15 GDO	£10-00	Shure 444	£14-00
Hanson swr bridge	£4-20	Acos Mic 45	£1-00
Double meter swr	£7-75	Yaesu p.t.t.	£3-00
5 band RF meter	£4-00	'J' Beam Halo	£1-35
Katsumi El bug EK9X	£8-50	Boom mic crystal	£4-60
Katsumi monitor	£2-20	Boom mic ceramic	£4-95
Type 500 test meter	£8-85	4 digit impulse counter	10p
Mhi test meter	£2-20	10 Crystals our selection	65p
Sentinel 2m. converter	£13-75	50 resistors	16p
Sentinel 4m. converter	£13-75	14/16 DIL sockets	15p
Sentinel 70cm. converter	£13-75	20 disc ceramics	15p
Sentinel 2m. pre-amp	£6-50	Eagle remote ct. mic.	£1-65
Soldering irons from	£1-45	10 ceramic capacitors	10p
2 way intercom	£1-00	10 silver mica caps	10p
'55' Dec	£1-00	Amphenol PL259 PTFE	30p
AR20 rotator	£220-00	Amphenol SO239	25p
AR22R	£25-00	Amphenol reducer	8p
3/16/7 3/9v. D.C. p.s.u.	£4-00	10 0-1 Mfd caps 400v.	15p
2,000 ohm headset	90p	Double sided copper clad	7p
C60 cassettes	30p	Paxolin 8" x 7"	3p
0-20v. D.C. p.s.u. 1A stab.	£10-75	2N3819, BF180	35p
2 1/2" speaker 8 ohm	35p	BC107, 108, 109	10p
3" speaker 8 ohm	40p	250 ohm carbon pots	25p
24v. relay ex equipment	10p	10 QSL strips (120 cards)	25p
12v. relay ex equipment	15p	RCA 3N 140 Mosfet	85p
5 mixed relays	50p	RCA 3N 141	85p
6 BA bolts pack	10p	6146 ITT	£1-80
6 BA nuts	10p	All RSGB publications stocked.	
Pack 20 ICs with data	£1-00	RSGB Callbook, post free	65p
Trio JR310 Rx	£75-00	Dosemeter	10p
Trio JR599	£185-00	Type 10 Xtal calibrator	£2-75

Second-hand equipment:

KW2000A and p.s.u.	£140-00	Codar 12/RC	£2-00
KW Viceroy 1V	£75-00	Codar PR30	£5-00
KW 2000A/B D.C. p.s.u.	£30-00	KW1000 linear amp.	£90-00
Sommerkamp FL200B	£85-00	Viceroy 100	£70-00
DF receiver 61044	£40-00	Unica UR1A	£20-00
Sentinel 2m. conv.	£10-00	Eddystone 940	£110-00
Trio TS150 and p.s.u.	£155-00	Heath RA-1	£25-00
Trio 9R59DS	£42-00	HRO and p.s.u. ex-ceptional)	£30-00
Trio JR500E	£45-00	Minimixer 2-7	£18-00
Trio JR310	£60-00	Pye hiband ranger	£8-00
Codar CR70A	£22-00	Pye lowband FM ranger	£8-00

A good chance to stock up with top grade disc ceramic capacitors. Most values 2-2 pfd to .1 mfd, send 10p stamp for full lists and samples. 50p for stock parcel (post 6p).

We are looking for good condition modern transmitters and receivers etc. and will pay cash or give good trade in prices. Please let us have details with s.a.e. for offer.

DES WOOD, G3HKO PLEASE ADD EXTRA FOR CARRIAGE. S.A.E. FOR LISTS

MAIL ORDER TO 28 HILLCREST AVENUE, SCARBOROUGH, YO12 6RQ (Telephone 63982)

RICHARD SELLERS EASTRINGTON, GOOLE, YORKSHIRE.

Telephone: 04305-254

PYE VANGUARDS 20w. Radiotelephones. Less accessories, with ccts. in good condition. Am25B Rx. has valve front end. Hi Band, £11-50, carriage £1. Low Band, £11, carriage £1. AM25T ALL TRAN. SITOR Rx. Hi Band, £17-50, carriage £1. Low Band, £14, carriage £1.
PYE CAMBRIDGE AM 10DV DASHMOUNT. Complete with mic, ccts., etc. In excellent condition. Low Band, £19-50, p.p. 75p. Hi Band, £21, p.p. 75p. FM DASH Cambridges. Hi Band in fine condition, £27, p.p. 75p. BQOT MOUNT Cambridges. Hi Band only Hi Band or Low Band, £17. C/W accessories, £22-30, carriage £1. LC10 FM Cambridges. 10 channel boat mount. Hi Band, 12w. output. All transistor except for Tx driver and PA YL1080. Very clean condition. Unit only less accessories and ledex switch, £14-50, carriage 75p. Replacement ledex, 50p. Sold only with unit.
PYE BASE STATION REMOTE CONTROL UNITS. Teak case. Few only £17, carriage 75p.
PYE WESTMINSTER HI BAND DASH MOUNT, £75, carriage paid.
Also available—Some units for 1 1/2 kHz channel spacing. S.A.E. requirements.

WORLD RADIO/TV HANDBOOK 1973

The World's only complete reference guide to International Radio & Television Broadcasting Stations. It includes: Frequencies, time schedules, announcements, personnel, slogans, interval signals and much more besides of value to the listener.

Lists all International short-wave stations, including frequencies, for each country; foreign broadcasts, long and medium wave stations (AM broadcast Band), TV stations and domestic programmes. Long recognised as the established authority by broadcasters and listeners. It is the only publication that enables you to identify BC stations quickly and easily. Enables you to fill more pages in your log book on the SW BC bands and helps you add more BC-station QSL cards to your collection.

£3-00

(The above price includes postage and packing).

from:

SHORT WAVE MAGAZINE
55 Victoria Street, London, SW1H 0HF

EMUVERTER 2 METRE CONVERTER

- ★ Plug in dual gate Mosfets, 116 MHz xtal, image rejection circuit, 28-30 MHz I.F. 12v. supply used.
£16 including postage

EMUPRESSOR SPEECH PROCESSOR

- ★ Battery powered, placed between mic. and Tx.
- ★ Virtually constant output for a wide input range, enables mod to be kept to an optimum over a wide range of speech levels.
- ★ Accepts input signals from 1mV to 1v.
- ★ Suitable for AM, FM or SSB.

£7-80 including postage

EMUMARKER CRYSTAL CALIBRATOR

- ★ Provides separate outputs at 1 MHz, 100 kHz and 10 kHz spacings up to 450 MHz.
- ★ Set up on Droitwich 200 kHz standard before dispatch.
- ★ Requires 9v. supply.

£7-80 including postage

MONEY BACK GUARANTEE ON ALL PRODUCTS

I. N. CLINE, G3EMU
15 KNIGHT AVENUE,
CANTERBURY, KENT,

CALLBOOK

(1973)

The "Call Book" proper is now published only once a year, in December, in two parts, "U.S." and "DX Listings."

Supplements to both editions appear at quarterly intervals, obtainable by prior order direct from the publishers.

We supply the "Call Book" as an annual publication, as required at any time during the year. We shall not be handling the quarterly supplements. These will be available only direct from the publishers.

This comprehensive reference lists about 300,000 licensed radio amateurs in the United States Directory and 160,000 or more in the rest of the world (contained in the "DX Section"). In the U.S. Section, licence classifications are shown with revised listings of new licences, names and addresses. The CALLBOOK also includes much incidental DX information. Every amateur operator and SWL needs the CALLBOOK to get the most out of Amateur Radio.

DX Listings £2-95

U.S. Listings £3-75

The above prices include postage and packing.

Your order to:

Publications Dept.,

SHORT WAVE MAGAZINE

55 Victoria Street, London, SW1H 0HF

01-222 5341

G3EKX S.S.B. PRODUCTS G3EKX

ADD 10% V.A.T. TO ALL ITEMS AFTER 31/3/73

EDDYSTONE ECI0. Mk. II	£86-00
EDDYSTONE 924. Power packs	£7-75
TRIO TRANSCEIVER. TS510/PSS10. New ...	£180-00
TRIO VFO 5 (TS500)	£21-00
LAFAYETTE HA230 RX.	£28-00
CLASS "D" WAVEMETER. A.C. mains	£11-00
EDDYSTONE 770R V.H.F. RX.	£95-00
COLLINS TCS12 TX. Less P.S.	£8-00
VICEROY Mk. 3A TX.	£55-00
(Carriage extra please)	

SPECIALLY MATCHED VALVES FOR LONGER LIFE

PAIR MATCHED 6HF5's R.C.A. ... (20p)	£5-50
PAIR MATCHED 6146 R.C.A. ... (20p)	£5-00
PAIR MATCHED 6146B R.C.A. ... (20p)	£6-20

CRYSTALS. New metal cased types. Mixed freq's from 201 kHz to 110 MHz. Please clearly state requirements and alternatives. Essential an s.a.e. is enclosed for reply. From

(5p)	ea. 60p
1-450, 2-5, 10-245, 24 MHz. Spot On ... (5p)	ea. 75p

SCARAB. S.S.B. Tx $\frac{1}{2}$ lattice Filters. Plus matching carrier xtal. (HC6/U xtals) all parts, instructions + 3 band Tx.-Circuit Hundreds in use. ... ea. £8-99

MORSE KEYS. Heavy brass. On wood base. Type C/1056A, back contacts. Large terminals. Unused, boxed ... (30p) ea. £1-20

SUPERB R.C.A. ROTARY RELAYS. 12v. D.C. input (hold in coil). Ideal for aerial switching 160m. to 2m. Changeover contacts. (3 sets). Only ... (24p) ea. 60p

1 FRANCES STREET, TRURO
Tel. DEVORAN 862575 CORNWALL

G. W. M. RADIO LTD.

ALL PRICES INCLUDE 10 PER CENT V.A.T

DOUBLE BEAM OSCILLOSCOPES CT436 (Military version of the Solutron CD 1014) D.C. to 6 Mc/s., 10Mv per Cm. sensitivity. Clean and in good order, **£54.50**, carriage paid.

RECEIVERS TCS. 1-5 to 12 Mc/s. Power needed 12v. A.C. or D.C., 220v. D.C. Clean untested condition, **£10.35**, carriage paid.

PYE RANGER. Dash mounting high band Radio Telephones, with Conversion crystal only, clean condition, **£6.55**, post paid. A few Murphy high band TR821/25, **£8.75** or low band TR801a, **£7.60**, post paid.

TRANSMITTER PA UNITS STC T4188. Tunes 2-8 to 18 Mc/s., Manual or 28v. motor driven. 13" x 8" x 8". Pair CV518 (4 x 150) 28v. blower cooled. Bases are NOT UHF type. Ideal basis for Linear Amplifier construction, **£8.75**, post paid.

PLESSEY PTR161. 24v. 6 channel remote Transmitter/Receiver 116-132 Mc/s. QV04-7 output. 6" x 8" x 11" weight 16 lbs. Good clean condition and complete with circuit and details of suggested 2 metre conversion and heater modifications to 12v., **£8.75**, post paid.

REDIFON S.S.B. Generator. 6315/a. 6 transistor plug in unit 9" x 6" x 12". No details, **£1.09**, post paid.

PARMEKO 200-250v. mains transformers, output 0-4.5-6-3v. 2a. **92p**, post paid. Larger potted type 0-10-10.5-11v., 0.75a., **71p**, post paid.

METERS. 500 microamp calibrated 0-1-4 kilowatts by Ernest Turner—Oblong 1 1/2" x 1 1/2". Also same make and specification but just over 3" square. Either type **£1.35**, post paid. 500ma 2 1/2" round, **65p**, post paid.

CRYSTAL CALIBRATORS No. 10 for Army 62 set, **£2.70**, post paid. Hygrometers, wet and dry bulb type, Centigrade **£1.35**, post paid. Moving coil microphones No. 13 with Plessey plug for B44, **65p**, post paid. Low impedance headphones with lead and two pole jack, aluminium headband, as new, **£1.25**, post paid.

REED RELAYS for G3FCW keyer, 4 reed normally open 200 ohms coil. 16p each, post for key number, 10p. Reed inserts 1.85" long (body 1.1") dia. 0.14". Gold clad contacts switch up to 500ma at up to 250v. D.C., **69p** per doz.; **£4.12** per 100; **£30.25** per 1000; **£275** per 10,000, all post paid.

BC221 Frequency meters with A.C. pack, **£18.60** or less pack, **£16.40**, carriage paid. Attenuators Marconi 70 ohms 10dB. Pye socket one end other special, **54p**, post paid.

All Receivers and Test Equipment are in working order at time of dispatch. Carriage charges quoted are for England and Wales only.

Telephone 34897

Terms: Cash with order. Early closing Wednesday

40-42 PORTLAND ROAD, WORTHING, SUSSEX

INSIST ON VERSATOWER

Acclaimed as the World's leading telescopic tiltover tower in the field of radio communication. Models from 25' to 120'

Enquiries to
Western Electronics (UK) Ltd
Osborne Road, Totton, Southampton

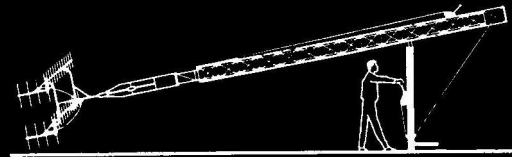

Look for the name

STRUMECH

Strumech Engineering Co Ltd
Coppice Side, Brownhills, Walsall, Staffs.

ENSIGN ELECTRONICS

- Speakers : 8Ω 2 1/2" **35p**, 40Ω 2" **35p**, 75Ω 2" **35p**
 - Headphones with Mic. New and boxed ... **£1.00**
 - Set of spare valves for 62 Set New ... **£1.35**
 - New Eagle 0-300 volt D.C. Meters. 3" square ... **£1.10**
 - AR88 SPARES** : Crystal Load Coils, **25p** ; Wavetraps ... **40p**
 - Mew Marked 2N3055 Transistors ... **35p**
 - 100 Mixed High Stability Resistors ... **35p**
 - 4" 8 Section Telescopic aerials ... **35p**
 - 67' wire aerials. Marked every foot ... **60p**
 - Aircraft Match Meters ... **70p**
 - Slide Switches 4 for ... **30p**
 - 10 1/2" Revox Tape Spools ... **40p**
 - Min. Silicon Bridge Rectifiers. 50 volt 1 amp. ... **25p**
 - IN4005's 600 volt P.I.V. 1 amp. ... **12p** each, 12 for **£1.30**
 - Valves : E180CC **20p**, Ruggedised E.F.91's ... **20p**
 - CAPACITOR OFFER** : 100 mfd 12 volt, **5p** ; 33 mfd 16 volt **5p** ; 0.05 mfd, 0.02 mfd, 0.002 mfd, 50 volts discs, 12 for **15p** ; 50 for **50p**.
 - 'Min' 'Battery Level' Meters. 0-600 M.A.F.S.D. ... **50p**
 - 25 Mixed Capacitors ... **30p**
 - Adjustable Hole Cutters ... **50p**
 - Set of 6 ex U.S.A.F. Maps (large, all different) ... **60p**
 - Lightweight Headphones—New and Boxed ... **£1.00**
 - Trimmers : Air Spaced 0-25 pf, 12p 0 0.5-5 pf screwdrivers type, **8p**.
 - Valve Bases, B7G, B9A, Octal ... **6p** each
- All Prices include Postage and Packing. Minimum Order 30p

V.A.T. Please add 5% to all prices to cover V.A.T.

SPECIAL OFFER. Ferric Chloride Powder for printed circuit etching. Full instructions. 1 lb. bag, **40p** ; 3 bags, **£1**

Starting in April our shop at the address below will be open every Saturday from 10.00 a.m.— 5.30 p.m.

Our range of good used Receivers includes :
AR88 L.F. with Handbook ... **£36.00**
B40S. Good Condition ... **£23.50**
Also in stock 19 Sets, Geiger Counters, Test Meters, etc.

**30 HIGH STREET, QUORN,
NR. LOUGHBOROUGH, LEICS.**

Eddystone Radio

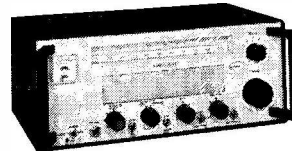

Model 1000

APOLOGIES

To all our friends in the retail trade for delayed deliveries to our U.K. distributor, Imhof-Bedco Ltd.

Problems in obtaining essential components for our greatly increased production programme have been solved and deliveries to Imhof-Bedco Ltd. will commence shortly.

Thank you for your patience and support.

EC 10 Mark 2

Eddystone Radio Ltd.

Alvechurch Road,
Birmingham B31 3PP

Tel.: 021-475 2231

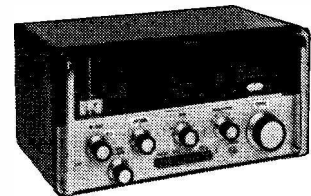

A MEMBER OF THE MARCONI COMMUNICATION SYSTEMS LTD.

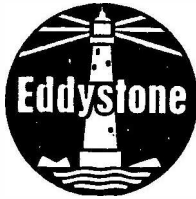

"LISTEN TO THE WORLD WITH EDDYSTONE"

Your local Eddystone dealer is:

CHESHIRE

The Transistor Centre (Wilmslow) Ltd
Green Lane
Wilmslow 24766

CORNWALL

R. V. Heming Ltd
(Peter Heming G3WBW)
Cliff Road, Newquay
Newquay 2191

S.S.B. Products
(Norman Birkett G3EKX)
1 Frances Street
Truro
Devoran 862575

DEVON

Reg. Ward & Co. Ltd: G2BSW
Axminster
Axminster 3163

ESSEX

F. E. Smith
184 Moulsham Street
Chelmsford
Chelmsford 54594

HAMPSHIRE

Southern Marine Radio
(Southampton) Ltd
Solent House, Town Quay
Town Quay 22721

IRELAND

John F. MacMahon
10, Church Street, Enniskillen
Co. Fermanagh, N. Ireland
Enniskillen 2955

LANCASHIRE

Holdings Photo Audio Centre
Mincing Lane - Darwen Street,
Blackburn BB2 2AF
Tel. 59595

Stephen-James Ltd
70 Priory Road, Anfield
Liverpool L4 2RZ
051-263 7829

North West Electrics
769 Stockport Road
Levenshulme, Manchester 19
061-224 4911

Croftfilm Ltd
46 Friargate
Preston PR1-2AT
Preston 55244

LEICESTERSHIRE

A. K. Davey Ltd
New Street, Hinckley
Hinckley 2173 and 4288

LONDON

Imhofs (Retail) Ltd
112-116 New Oxford Street
W.C.1
01-636 7878

R. T. & J. Electronics Ltd
Ashville Old Hall
Ashville Road
Leytonstone, E.11
01-539 4986

Radio Shack Ltd
188 Broadhurst Gardens
London, N.W.6
01-624 7174

NORTHUMBERL'D

Aitken Bros. & Company
35 High Bridge
Newcastle upon Tyne NE1 1EW
Newcastle upon Tyne 26729

WALES

Holt High Fidelity
Picton Arcade, Swansea
Swansea 53254

Holt High Fidelity
8 Portland Street, Swansea
Swansea 41032

WARWICKSHIRE

Chas. H. Young Ltd
170/172 Corporation Street
Birmingham 4
021-236 1635

TAURUS ELECTRICAL SERVICES

26-28 NOTTINGHAM ROAD, LOUGHBOROUGH, LEICS.

Telephone : 05093-5131



We stock all TRIO communication equipment and most of the SOMMERKAMP gear. If we've not got it we do our utmost to get it for you. Now we have ACCESS for purchasers of all Amateur Radio equipment, New and Second-hand.

THIS MONTHS BARGAINS

BOXED NEW 4CX250 BASES.	Complete with chimneys and securing clips	£3-20
NEW MULLARD 1" END-ON NIXIE TUBES		£1-30
Bases for same		12p
807 BASES	each	10p
FIELD STRENGTH METERS		£3-10
NEW EDDYSTONE 10-7 Meg. IFs		12p
RF Chokes		10p
Large Knobs		25p
NEW GORLER Dual IF Amplifiers, 10-7 Meg. and 465 kc/s. with circuit		£3-20
Spare last IF's for above		15p
NEW 8 Ω 3" Loudspeakers		35p
40 Ω 2" Loudspeaker		40p
SHURE LOW IMPEDANCE MIKES		£1-75
DESK HIGH IMPEDANCE MIKES		£3-25
ACOS MIC 40		£1-50
HAND MIKES	80p, 90p and £1	
SLOW MOTION DIALS		
Small 65p	Medium 85p	Large £1
TELEPRINTER 7B's in stock		£15-00 to £25-00

All goods advertised last month still available

OSCARBLOCK SWR and POWER METERS	£18-50
FX2000 CRYSTAL MARKER GENERATORS 100 kHz/50 mHz with switchable modulator	£5-75
MG 100 AUDIO GENERATORS sine and square wave, 19 Hz - 220 kHz...	£17-50

All prices include carriage

All orders over £2 confirmed by return if any delay

You can order these goods by letter or telephone

SIMPLY QUOTE YOUR ACCESS NO.

KW ELECTRONICS LTD
require
TEST ENGINEERS for SSB EQUIPMENT
and
QUALITY CONTROL INSPECTOR
Good Salary — Interesting Work

Apply in confidence, giving personal details, experience, present salary, to:
The Works Manager, KW Electronics Ltd.
23 High Street, Crayford, Kent.
or Telephone for an appointment Crayford 22040.

TRIO For reliability

Short Wave and Hi-Fi

Swop it for your camera

AT HOLDINGS MINING LANE / DARWEN STREET BLACKBURN TEL: 59595

2 METRE CONVERTERS

LOW NOISE R.F. STAGE F.E.T. MIXER. Xtal controlled multiplier chain. Aluminium case. Size: 4" x 3" x 1 1/2". I.F.'s 4-6, 18-20, 24-26, 28-30 MHz, £11-55 each.

2 METRE LOW NOISE CASCODED F.E.T. PRE-AMPS. Aluminium case. Size: 2 1/2" x 1 1/8" x 1 1/4", £5-50 each.

E & E SERVICES
72 ELMSTONE ROAD, RAINHAM, KENT.

R.C.A. 2N 3553 TRANSISTORS at 80p each. 3 for £2.
50 PIV 1 Amp SILICON BRIDGES at 25p.
VHF-UHF TUNING VARACTORS untested 50pf at 8 volt, 80pf at 4 volt. 6 for 25p.
 Packet of 25 **PRINTED CIRCUIT SILICON DIODES** untested up to 1000 PIV 500 mA at 25p.
ITT BCY43 GENERAL PURPOSE SILICON NPN TRANSISTORS, 5p each. 40p doz.
600 MHz MADD unmarked MSD 39 PNP TRANSISTORS, 5p each. 40p doz.
FET's 2N 3819 at 30p ea. 4 for £1, 2N 3824 at 20p. BFW10 at 25p ea. 5 for £1, BFW11 at 25p.
COMMUNICATION SERIES OF I.C.'s untested containing 1 x R.F., 3 x I.F., 2xVOGAD, 2xAGC, 1 x Heaphone Amp, 2 x Balanced Modulators, 1 x Mixer. The 12 I.C.'s at £2.75.
 Separate I.C.'s at 25p ea.
100 PIV 10 Amp SILICON BRIDGES at 75p ea.
M.O.S. LOGIC I.C.'s UNTESTED
 Dual 3 Input Nand Gate. Dual 3 input And-Or Gate.
 Dual 3 input Nor Gate. 6 input Nor-Or Gate.
 Counter Register Bistable element. 24 Bit Dynamic Shift Register.
 Quad Address. Multiple And.
 8 Bit Shift Register. Quad 10 Bit Shift Register.
 All above in 14 Lead Dual in Line at 3 for 25p.
MISCELLANEOUS TRANSISTORS. 2N 1499A, 2N 1744, 2N 2788, 2N 3344, 2N 3392, 2N 3402, 2N 3721, 2N 3859, 2N 3877A, 2N 4386, 2N 4415, 2N 4412, 2N 4951, 2N 4953. All at 10p each.
 1000 PIV 1 amp **SILICON DIODES** at 10p each.
 200 watt **TRIAC LIGHT DIMMER KIT** at 90p.
MULLARD POWER TRANSISTORS BD 131 at 50p, BD 132 at 50p. F.M. I.F. I.C.'s similar to TAA 570 untested with data. 5 for 50p. Further supply of 300 MHz **DIVIDE BY 2 COUNTERS** at 60p ea. with data.
 Ex-New Equipment **400 PIV 5 Amp S.C.R.'s** at 3 for 50p. 7 for £1.
DUAL 2GHZ NPN TRANSISTORS untested 2 pair for 50p.
TRANSISTOR PACKAGE similar to CA 3045 containing one Matched pair plus 3 Separate 600 MHz NPN TRANSISTORS. Untested with data. 5 for 50p.
100 Untested 2 WATT ZENERS at 50p. 100 400mV ZENERS untested at 50p.
12 Volt 500mA STABILISED POWER SUPPLY at £2.50.
6 KHz CRYSTALS in 87G Glass envelope at £1.
HIGH VOLTAGE NPN POWER TRANSISTORS 250 volt TO 66 case at 20p ea.
Pack of 1000 GENERAL PURPOSE GERMANIUM CRYSTAL DIODES. Cathode end marked £2.
12 VOLT AMPLIFIER-FM DETECTOR like TBA 750, Five-Stage Limiting Amplifier with a Balanced Product Detector, D.C. Volume Control and Audio Driver untested. 4 for 60p with data. PLEASE ADD 10% VAT ON ALL PRICES

J. BIRKETT 25 THE STRAIT, LINCOLN, LN2 1JF. Telephone: 20767
 Radio Component Suppliers



become a RADIO-AMATEUR!

learn how to become a radio-amateur in contact with the whole world. We give skilled preparation for the G.P.O. licence

free! Brochure, without obligation to: SWB-43

BRITISH NATIONAL RADIO & ELECTRONICS
 SCHOOL P.O.BOX 156, JERSEY, CHANNEL ISLANDS

NAME : _____
 ADDRESS : _____

_____ BLOCK CAPS please

THE AMATEUR RADIO SHOP 64MH
 13 CHAPEL HILL, HUDDERSFIELD,
 Telephone: 20774

(MEMBER OF THE AMATEUR RADIO RETAILERS ASSOCIATION)

Agents for **Eddystone, Yaesu, KW, Trio, J Beam**
 Barclay Card, H.P., etc.

PLEASE ADD 10% VAT TO THESE PRICES AFTER 1st APRIL

Now in stock :

Full range of KW : 2000E, 2000B, 202, 204, 1000LIN, 107, 103, Eze Match, Antenna Switch, etc.

Full range Trio : TS515, TL911, TX599, JR599, JR310(160), 9E59DS, TR2200, Filters, Mics., etc.

Yaesu : FT101(160), FT200, FT401, FT400SDX, FR400, FR50B, FL50B.

Accessories: Copal 222, 24 hr., £7; Copal 601, 24 hr., £14.95; T.T.C. SWR Ind., £6.75; Shure Mics. 201, £5.75; Shure 444, £12.50; Shure 444T, £16; Shure 401, £6.75. Rotators, Beams, Cable, Calves, etc.

Crystals : HC6U 8041-66 £1 each. 10XJ (CRI/AR) 8001 to 8107. S.A.E. lists, at 75p each.

Morse Practice Oscillator including Integrated Circuit, Loud Speaker fully wired, 90p incl. post.

The 4 MH 2 Metre Tx now available again 16 watts input xtal supplied, £11.50. Also matching Modulator EF86-ECC83-2XEL84, £11.50. S.A.E. details.

Second-hand :-

JR599	...	£140	Halicrafters SX 133 & L/S	£95
EA12	...	£140	KW Atlanta & PSU/VOX	£140
770R	...	£95	JR 310 & 160, Cal, Filter...	£75
FP20 Pan Adaptor	...	£50	JR 500 Mint.	£45
Viceroy Mk. III	...	£55	9R59DE	£30
KW 2000B	...	£170	SX 28. & L/S	£25
HA350	...	£55		

WANTED ALL TYPES OF GEAR FOR CASH

S.A.E. for any gen.

CLOSED TUESDAYS, LATE NIGHT THURSDAYS

73 G4MH, G3NEW

SOLID-STATE RTTY CONVERTER-KEYER SRD-1

- COPIES 850/400/170 HZ SHIFTS
- BUILT-IN SINGLE AND DOUBLE CURRENT PSU
- F.S. KEYER FOR TX (AND OPTIONAL AFSK)

Complete and ready-to-go for send-receive RTTY with TX, RX and teleprinter.

- Advanced circuitry, 6 ICs, 25 semi-conductors. ● Input matches receiver outputs 3-8 or 500-600 ohms. ● 3-pole Butterworth input bandpass filter. ● Switched 850/400/170 Hz Amateur/Commercial shifts but copies shifts 1000 Hz down. ● 2-pole low-pass filter. ● Tuning meter. ● Monitor scope outputs. ● Mark Hold and Normal/Reverse shift switch. ● Built-in loop PSU—Instant switch-selection of single- or double-current printers. ● Narrow-shift CW identification. ● F.S. Keyer output for TX. ● Socket and circuitry already fitted for optional plug-in AFSK keyer module, 850/170 Hz. ● Manual. ● Two-tone pvc-coated case, 9" w x 3 3/8" h x 14" d. Weight : 7 lbs. **SRD-1, £49.50.**

(Optional plug-in AFSK module, SRD1-AK, £5.75. SRD-1 complete with SRD1-AK, £55.00).

RTTY CONVERTER-KEYER Model TTU, £120. ST-5 PCBs and datasheets, £4.15. **TOROIDS** 88 mH, 75p per pair. **ST-6** PCBs and datasheets, £11.75. **ST-6 KIT** complete less case, with datasheets, £62.50. **SAMSON ETM-2b**, £23.80. **ETM-3b**, £25.95. **JUNKER** Precision hand key, £9.75. **BAUER** keying lever, £3.80. **SSB 90° AUDIO PHASE SHIFT NETWORKS**, £2.95. **PRINTSET** Basi-kits.

ADD 10% V.A.T. FROM APRIL 1st.

All goods post-paid U.K. Send stamp for Catalogue SP5.

SPACEMARK LTD.
 THORNFIELD HOUSE, DELAMER ROAD,
 ALTRINCHAM, CHESHIRE.

(Tel. 061-928 8458)

RADIO AND ELECTRONIC HANDBOOKby **G. R. Wilding**

Technicians and service engineers in the Radio and Electronics industry require a considerable amount of data which is spread over many books. It is often difficult and time consuming to locate in a hurry. Students, however, who may have to study a whole series of course-books will find a condensation of such information, which gets down to the essentials, extremely useful. *Radio & Electronic Handbook* has been designed to provide, on the one hand, a reference book and, on the other, a revision guide.

The intention has been to summarise basic electronics into four separate, easily assimilated sections, which will provide rapid reference to important principles, formulae and applications. These four main sections are: Direct current theory; Alternating current theory; Valve theory and applications; and Transistor theory and applications. Practical worked examples and circuits diagrams have also been utilised whenever necessary.

The concise presentation, which covers all the relevant ground, makes for easy learning and the book should prove invaluable for both practical and examination requirements. **£1.28**
149 pages including 84 diagrams.

QUESTIONS AND ANSWERS ON RADIO AND TV

3rd Edition

PREFACE

Curiosity is the keystone of learning. The man who "wants to know" has a far better chance of digesting and retaining information than he who ploughs through a set subject simply because it has been put before him.

Hence the "Question and Answer" form of this little book. Wherever possible, the questions have been arranged to follow the growth pattern of information. Questions arise from the previous answers. This means that the book differs from a standard textbook in that subjects are not cajoled neatly into place; except that main chapter headings give a guide to the line of questioning, the reader can treat these pages as bedside or benchside reading. Mathematics and unwieldy formulae have been avoided. Circuits and other diagrams give the basic information and confusing frills are omitted.

There are many textbooks to which the reader who wishes to augment the information given here can resort. These chapters will whet his curiosity **83p**

PRINCIPLES OF AERIAL DESIGNby **H. Pope**

The principles involved in the design of aerials are by no means easy for the student to assimilate because they require a knowledge of field theory, which involves more difficult concepts than the more familiar circuit theory. In an endeavour to be precise and exhaustive it is all too easy to complicate the treatment, and so become involved in a welter of abstruse mathematics. On the other hand, if the subject is over-simplified the treatment can easily become purely descriptive, at the expense of an understanding of the principles involved.

In this book—which is not exclusively of amateur-band interest but more on Aerial Theory for the general reader—the author attempts to steer a middle course between these two extremes. The theory of aerials is developed from first principles, but where approximations are necessary in order to avoid mathematical complication the reasons are given and the significance of the approximations indicated. By this means the reader is given a succinct introduction to the more important aspects of the theory of aerials while the practical forms used in the frequency bands up to 30 MHz are also briefly described.

It opens with an exposition of the laws governing electric and magnetic phenomena upon the basis of field theory, and the fundamental concepts and quantities are introduced and defined. The theory and practical applications of Maxwell's electro-magnetic wave equations are next dealt with (and there is an appendix which gives the derivation of the vector formulae employed). The next chapter is concerned mainly with the two important characteristics of an aerial for transmission or reception—the radiation pattern and the impedance—while the final chapter describes the practical forms which aerials take for particular uses and the various techniques employed to obtain the best effect.

The author has been employed for many years in the Research Department of the British Broadcasting Corporation; he also gives a post-graduate course of lectures on Aerials and Propagation in the Electrical Engineering Department of Imperial College, London. His book is as much for the seriously interested amateur as for the professional. 172 pages, including 96 text diagrams, plus 6 pages of art plates. **£2.60**

DICTIONARY OF ELECTRONICSby **Harley Carter, M.I.E.E.**

The field of electronics has widened to such an extent that, with the new terms introduced in specific branches of the subject, the student and even the scientist find it difficult to keep up with new developments. Many engineers trained in alternative fields of technology are nowadays having to apply their knowledge to electronics. It is with these points in mind that this illustrated dictionary is presented.

Priority has been given to the inclusion of fundamental facts and terms, and the other entries to a large extent follow on from these. Also listed are familiar terms and descriptions of many electronic instruments. Much supplementary material is given as an Appendix, including circuit symbols, abbreviations, colour codes, conversion tables and valve bases.

The concise but explanatory definitions from many branches of electronics—including radio, television, communications, radar, electronic instrumentation and industrial electronics—should prove of use to engineers, students, technicians, apprentices and to all those whose work or interest requires them to understand modern electronic terminology. **£1.88**
Second Edition

INTEGRATED CIRCUIT POCKET BOOKby **R. G. Hibberd**

This book is a logical companion to the Authors' previous book—The Transistor Pocket Book, and is intended primarily for technicians and students whose courses include semi-conductors devices, but it will also be of interest to all those who are concerned with integrated circuits and their applications.

£2.60 (post free)**DICTIONARY OF TELECOMMUNICATIONS**by **R. A. Bones, B.Sc., Ph.D., ACIS, CEng., M.I.E.E., AInstP.**

Economic growth throughout the world is closely linked with the development and growth of telecommunication systems. Modern industry demands ever-improving facilities for its executives to be able to speak to each other from opposite sides of the globe; to be able to transmit drawings, documents and pictures rapidly over large distances; and now to be able to send data accurately and quickly from computer to computer.

Telecommunications is an industry with a high growth rate and, like all technologically based industries, a new language has developed: a language which grows daily as new materials, techniques and systems are developing. This dictionary is an attempt to document that language.

The wide range of definitions, including many reproduced from, or based on, British Standards recommendations, is supplemented by appendices including units and abbreviations, wavelengths and frequency bands, and signal reporting codes.

The concise explanations of the terms in use should prove valuable to engineers, students, technicians, and to all whose work or interest requires them to understand modern telecommunication terminology. **£2.35**

MICROPHONESby **A. E. Robertson**

A general treatment, in twelve chapters with appendices.

£1.40**WIRE ANTENNAS FOR RADIO AMATEURS**by **W. I. Orr**

What this Handbook contains:—How to build tested wire antennae (for two metres to 160m.—Top Band) that really get out—horizontals, verticals, beams, trap antennae, ground planes, etc.

"Invisible" aerials for amateurs in flats and other locations where radio and TV antennae are "prohibited."

Exact dimensions in feet and inches—also in metres and centimetres—for every antenna described—no guesswork!

How to build two "all-purpose" aerial tuners with 100 uses!

The truth about baluns. How to build an efficient, inexpensive balun for optimum antenna performance and accurate SWR readings

The construction of 2, 3, 4 and 5-band trap dipoles. How to make your own efficient traps and save real money.

Three-band dipole for 80, 40 and 15 metres—only one feedline!

Ground plane aerials for VHF and 10, 15, 20 and 40 metres.

High-gain beam antennae especially suited for VHF FM.

The efficient "folded Marconi" antenna for 40, 80 or 160 metres.

Clear explanations of resonance, radiation resistance, impedance, standing wave ratio (SWR), balances and unbalance aerials.

Plus—radial wire ground systems; lightning protection; wood masts; counterweights; the easy way to use coax connectors—and much more!

This book is an American publication by a well-known author in the field of Amateur Radio. **£1.72**

Available from**Publication Dept., 55 Victoria St., London SW1H 0HF****01-222 5341**

(Counter Service. 9.30-5.15. Mon. to Fri.)

(Nearest Station: St. James's Park)

(GIRO A/C. No. 547 6151)

Technical Books and Manuals

(ENGLISH AND AMERICAN)

AERIAL INFORMATION

ABC of Antennas	90p
Aerials (By D. Sjobbema)	88p
Aerial Handbook (Briggs)	87p
Amateur Radio Antennas (Hooton)	£1-87
Antenna Handbook, Volume 1	£1-77
Antenna Round-Up, Volume 1	£1-47
Antenna Round-Up, Volume 2	£1-77
Antenna Handbook, 12th Edition (ARRL)	£1-40
Beam Antenna Handbook, 4th Edition	£2-10
Quad Antennae, 2nd Edition	£1-80
Simple Low Cost Wire Antennas	£1-72
73 Vertical, Beam and Triangle Antennas (by E. M. Noll)	£2-40
73 Dipole and Long-Wire Antennas (by E. M. Noll)	£2-20

BOOKS FOR THE BEGINNER

Amateur Radio (Rayer)	£1-60
Beginners Guide to Radio (7th Edition)	£1-12
Beginners Guide to Electronics (N.E.)	£1-10
Beginners Guide to Transistors	£1-12
Beginners Guide to Colour TV	O/P
Better Short Wave Reception, 2nd Edition	£1-80
Course in Radio Fundamentals (N.E.)	£1-15
Foundations of Wireless and Electronics	£2-02
Guide to Amateur Radio (N.E.)	89p
Ham Radio (A beginner's Guide) by R. H. Warring	£1-72
How to Become a Radio Amateur	59p
Learning the RT Code	27p
Morse Code for the Radio Amateur	15p
Radio, by D. Gibson	85p
Radio Amateur Examination Manual (N.E.)	89p
Simple Short Wave Receivers (Data)	89p
Understanding Amateur Radio	£1-37

GENERAL

ABC of Electronics (by Earl J. Waters)	£1-20
ABC of FET's	£1-35
ARRL Calculator, Type A	92p
Easibinder (to hold 12 copies of Short Wave Magazine together)	90p
FET Principles, Experiments and Projects	£2-15
Guide to Broadcasting Stations (16th Edition)	60p
Having Fun with Transistors	£1-59
How to Listen to the World—7th Edition	£1-90
Know Your Oscilloscope (by Paul C. Smith)	£1-80
Microphones	£1-65
Practical Integrated Circuits (Newnes-Butterworth)	£1-01
Practical Transistor Theory	£1-10
Practical Wireless Circuits	£1-34
Prefix List of Countries	23p
Radio Engineers Pocket Book (Newnes) (N.E.)	£1-26
RCA Designer's Handbook (Solid State Power Circuits)	£3-50
RCA Receiving Tubes Manual	£1-77
RCA Transistor Thyristor and Diode Manual	£1-75
RCA Transmitting Tubes	£1-35
Shop and Shack Shortcuts	£1-75
Single Sideband: Theory & Practice (by H. D. Hooton)	£3-47
Telecommunications Pocket Book (T. L. Squires)	£1-32

World Radio and TV Handbook 1973 Edition	£3-00
110 Integrated Circuit Projects for the Home Constructor	O/P
49 Easy Transistor Projects	£1-01
110 Semi-Conductors Projects for the Home Constructor (Iliffe)	£1-37

HANDBOOKS AND MANUALS

Amateur Radio DX Handbook	£2-17
Electronic Circuit Handbook, Vol. 1	£1-42
Electronic Circuit Handbook, Vol. 2	£1-42
Mobile Handbook, CQ	O/P
Mobile Manual, ARRL	O/P
New RTTY Handbook	£1-80
Radio Amateur Handbook 1973 (ARRL)	£2-85
Radio Amateur Handbook 1973 (ARRL) (Hard Cover)	£3-65
Radio & Electronic Handbook	£1-32
Radio Amateur Operators Handbook, 12th Edition	53p
Radio Communication Handbook (RSGB)	£4-10
Rtty A-Z (CQ Tech. Series)	£2-25
Surplus Conversion Handbook	£1-37
Television Interference Manual (G3JGO)	90p
Transistor Substitution Handbook No. 10	£1-12

USEFUL REFERENCE BOOKS

Amateur Radio SSB Guide	£1-59
Amateur Radio Techniques—4th Edition	£1-80
Care & Feeding of Power Grid Tubes (Elmac Division of Varian)	£1-60
Engineers' Pocket Book—6th Edition	£1-48
Guide to Amateur Radio	50p
'G' Call Book 1973	70p
Hams' Interpreter	63p
Hints and Kinks, Vol. 8 (ARRL)	62p
Operating an Amateur Radio Stat.	O/P
Radio Amateur Examination Manual (N.E.)	89p
Radio Data Reference Book (3rd Edition)	£1-00
Radio, Valve and Transistor Data (Iliffe), 9th Edition	89p
Service Valve and Semiconductors Equivalents	35p
Single Sideband for the Radio Amateur (ARRL), 5th Edition	£1-67
Single Sideband (Theory & Practice) by H. D. Hooton	£3-47
Sun, Earth and Radio by J. A. Ratcliffe	91p
Surplus Schematics (CQ)	£1-22
Transistor Pocket Book	£1-57

TRANSISTOR MANUALS

ABC of Transistors	£1-33
Field Effect Transistors (Mullard)	£1-95
Having Fun with Transistors	£1-59
Handbook of Transistor Circuits	£2-35
Transistor Audio & Radio Circuits (Mullard)	£1-96
Transistor Fundamentals: Basic Semi-Conductor and Circuit Principles, Vol. 1	£1-92
Transistor Fundamentals: Basic Transistor Circuits, Vol. 2	£1-92
Transistor Substitution Handbook, No. 12	£1-50

VHF PUBLICATIONS

VHF Handbook, Wm. I. Orr	£1-79
VHF Manual (ARRL)	£1-37
VHF/UHF Manual (RSGB) (N.E.)	£1-80

O/P (out of print)

The above prices include postage and packing.

Many of these Titles are American in origin.

Available from

Publication Dept., 55 Victoria St., London SW1H 0HF

(Counter Service. 9.30-5.15. Mon. to Fri.)

(GIRO A/C. No. 547 6151)

SHORT WAVE MAGAZINE

01-222 5341

(Nearest Station: St. James's Park)

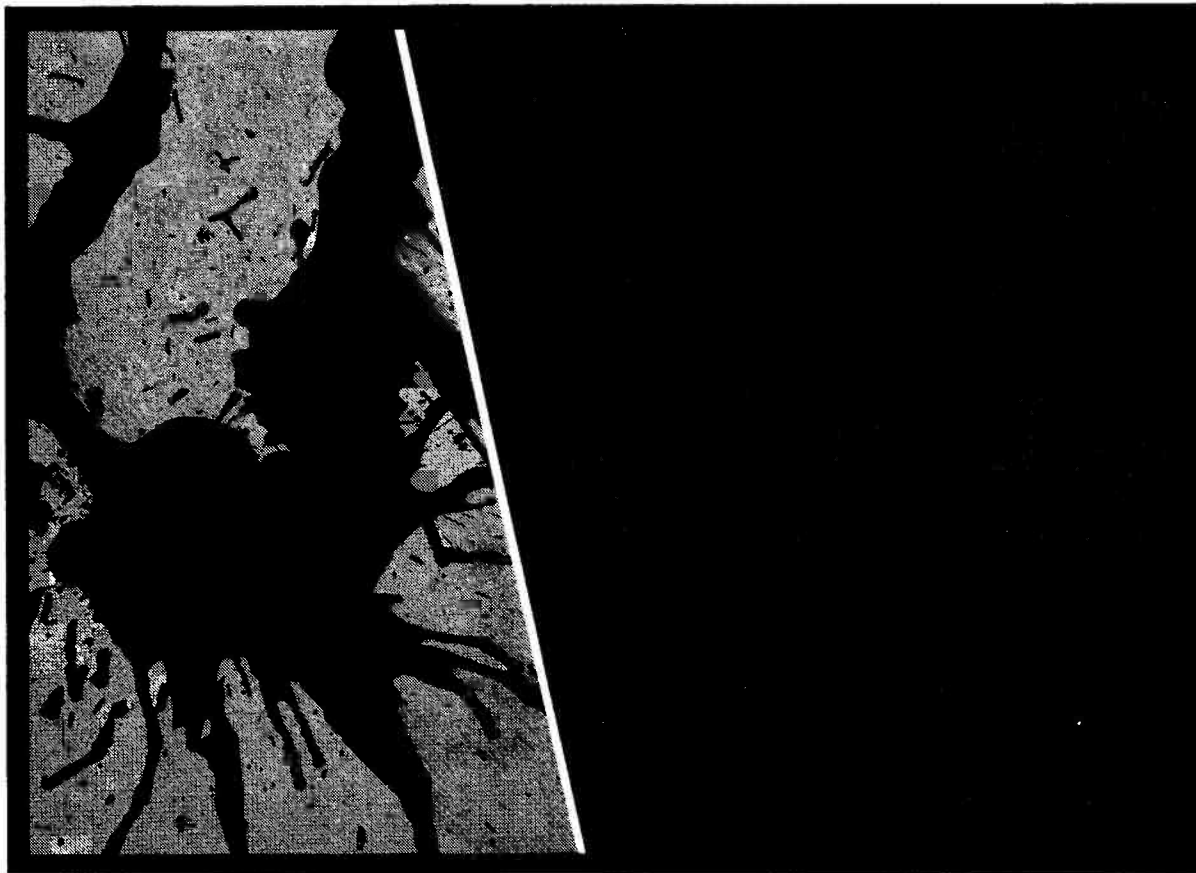

SSB-ers:

increase talk power, cut "splatter"



Our 444 base station microphone not only gives you increased talk power, but cuts "splatter" (and QRM complaints) to an absolute minimum! It has superbly tailored response, with sharp cutoffs below 300 and above 3,000 Hz and a rising response characteristic for maximum intelligibility. The 444's rugged, reliable Controlled Magnetic element has been proved in safety communications, and other tough professional communications applications. It delivers a clean signal to the transmitter at levels as high as crystal units! (And, unlike crystal and ceramic units, the element is totally immune to the effects of temperature and humidity.) The 444 also features an adjustable height stand that makes for comfortable "ragchewing" sessions, an optional-locking bar for push-to-talk or VOX operation, and a practically indestructible Armo-Dur® case. Write:

Shure Electronics Limited
84 Blackfriars Road
London SE1 8HA, England



P. & P. DEVELOPMENTS

Havant 72657
Shop Hours

WE SPECIALISE IN VHF EQUIPMENT
FOR THE PROFESSIONAL AND AMATEUR!

Cosham 74695
Evenings, Weekends

MURPHY 821. High band AM TX/RX QQV03-10 final and driver stages, easily converted to 2m. ... £9, carr. 75p
MURPHY 820. Mid-band dash version of the 821, good condition will convert to 2 or 4 with circuit ... £6, carr. 75p
MURPHY 807. High power AM mobiles for 2 or 4 less QQV03-20A but otherwise complete ... £6, carr. £1
MURPHY BASE STATIONS. High power AM complete units inc. p.s.u. ... £25, carr. £2
COSSOR CC15. Lowband AM Mobiles QQV03-20A final, complete with all leads, speaker, mic., etc. ... £16-50, carr. £1
GEC LOW BAND BASE can be modified to 12½ kHz £27-50, carr. £2
PYE AM10B. Highband 12½ kHz (new GPO spec.) complete with all accessories in good condition ... £60, carr. £1
PYE R470. UHF Rx. all solid state, mint condition, ideal for 70 cms. receiver ... £45, carr. £1
PYE. Highband AM monitor receiver, 4 channels, ideal for converting to a 2m. base Rx., very clean condition... £35, carr. 75p
HEATHKIT SB300. Amateur bands receiver, mint condition, fitted noise limiter and speaker ... £80, carr £1-50
B44 Mk. III. Ideal for 4m. ... £8-50, carr. 75p
PLESSEY PV215. High quality SSB/DSB/AM/ISB driver units, output frequency 100 kHz. Can be operated independently on USB and LSB at same time. Output level via 0-6 dB atten. LC type filters, superb xtal ovens. The units are completely transistorised and in mint condition. £30, carr. £1
PLESSEY PVT23A. This unit will accept the 100 kHz above and mix giving output on 3-1 MHz ... £20, carr. 50p

RADIO ALARMS. New Murphy radio alarm units, contains 12v. p.s.u. audio board multi-programme cam unit. Ideal for host of spares, or as radio alarm ... £1-25, carr. 75p
PYE MARINE TX. Runs 2 x 5B254M's in final AM/CW/MCW xtal control on 8 channels or VFO in 1.5-16 MHz continuous coverage. In good condition complete only ... £10, carr. £1-50
PSU's for above Tx less valves but with control unit, £4, buyer collects
HF VFO/PA. Contains 2 x 4X150A's chimney and blower, good condition ... £12, carr. 75p
VHF FIBREGLASS WHIP AERIALS. Ideal for cutting to ¼ wave on 2m. ... £1, carr. paid
MULLARD. Tubular ceramic trimmers 0-6pf 14p, 0-12pf, 19p ea.
INVERTER PSU's. 24v. input 425v. and 125 watts output. New. £4-25, carr. 50p
LOW VOLTAGE RELAYS. 24v. octal fitting ... 50p ea. or 3 for £1-25, carr. 10p
MICINSERTS. Dynamic and carbon. ... 50p each, carr. 10p Lustraphone dynamic ... £1 ea., carr. 15p
STC 633. High band AM 12½ kHz mobiles, good condition £65, carr. £1

PLEASE ADD 10% FOR V.A.T. TO ALL PRICES.

G8DBX

19 LONE VALLEY, WIDLEY, COSHAM, PORTSMOUTH, HANTS.

Subscription rate to
Short Wave Magazine is
£3.00 (First Class) £2.75 (Second Class)
for twelve issues.

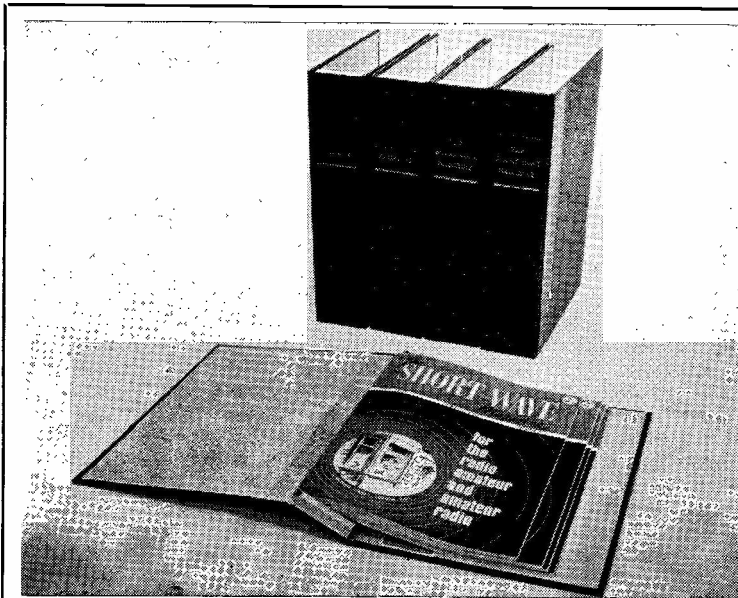

CREATE YOUR OWN REFERENCE LIBRARY

The "EASIBINDER" is designed to bind 12 copies of the Magazine as you receive them month by month, eventually providing a handsomely bound volume for the bookshelf.

No need to wait until twelve copies are assembled. As each copy is received, it is quickly and simply inserted into the binder. Whether partially or completely filled, the binder is equally effective, giving the appearance of a book, with each page opening flat.

Strongly made with stiff covers and attractively bound in maroon Leathercloth and Milskin, the binders have only the title gold blocked on the spine.

Price 90p post free.

PUBLICATIONS DEPARTMENT
SHORT WAVE MAGAZINE
55 VICTORIA STREET
LONDON, SW1H 0HF

SOME TITLES FROM FOULSHAM-SAMS

ABC's of ANTENNAS

The introductory chapters cover the fundamentals of radio-wave propagation and basic antenna characteristics. The remainder of the book is then devoted to a discussion of the various types of antennas and their uses. Antennas for radio, television and two-way communications are included. Business radio, amateur, both mobile and fixed-station operation, are covered. The final chapter should be particularly appealing to those interested in microwave uses and radio-navigational systems. A perusal of this book will provide any student with an excellent foundation for more advanced study in antenna design.

89p

AMATEUR RADIO SSB GUIDE

Single-sideband receivers, transmitters, and transceivers are now available which have higher frequency stability and are much easier to tune than the early models. In this book, the author presents a guide to single-sideband and single-sideband equipment, which will be useful to any amateur considering or already operating SSB.

By W6TYH

£1-59

BEGINNER'S GUIDE TO RADIO

For many years "Beginner's Guide to Radio" has been extremely popular as an introduction to the subject of radio-and-how-it-works. The many advances made in recent times have rendered a new edition necessary.

This seventh edition has been completely rewritten and brought up-to-date to take account of the latest techniques and methods, and covers every aspect of the modern radio scene, while including the important basic information necessary for the newcomer to the subject.

The reader is guided from the first principles of electricity and magnetism, through radio waves, modulation and radio components, including valves and transistors, taking in radio transmitters and stereo broadcasting, and ending with hi-fi reproduction.

The book will be of interest to all who wish to understand the how-and-why of radio, whether it be for a hobby or a profession.

Seventh Edition

£1-12 post free

RADIO AMATEUR OPERATOR'S HANDBOOK

The opportunity has been taken of bringing this edition—the twelfth—right up-to-date and of incorporating extensive revisions. The book covers in detail the Post Office regulations governing the issue of transmitting licences.

The purpose of this Handbook is to provide all the information which the operator of a radio station may need about such matters as Country Prefixes, Call Sign Areas, Frequency Allocations, Standard Frequency Transmissions, Time Factors, Distance Tables, and so on. For the newcomer, this manual enables him to find the basic answers and to obtain the maximum pleasure from his hobby.

53p post free

TRANSISTOR FUNDAMENTALS Vol. 1

This book is a carefully planned programmed introduction to semi-conductors and the basic electrical circuits. It begins with a brief description of transistors and later devotes an entire chapter to an explanation of transistor principles. Sandwiched between these chapters are explanations of voltage, current, and resistance; and the all-important Ohm's Law and Kirchhoff's laws. The book also looks at the more complicated nature of inductance, capacitance, and resistance in AC circuits.

£1-92

TRANSISTOR FUNDAMENTALS Vol. 2

This volume describes transistors and how they are used in semi-conductor circuits. Simple circuits illustrate the basic principles involved, and the more complicated circuits found in amplifiers and oscillators help to show how the basic operations are applied. Later, some recent semi-conductor developments are discussed. Detailed descriptions of four new transistor devices are given and how they are being used.

£1-92

KNOW YOUR OSCILLOSCOPE

By Paul C. Smith

The oscilloscope provides you with a "third eye" which lets you see what is actually happening in electronic circuits. But you must know something of the nature of this valuable instrument, and how to use it, before it will serve you. This book presents complete information on the circuitry, functions, and applications of the oscilloscope in easy-to-understand language. Worthwhile reading for anyone who uses an oscilloscope... a "must" for service technicians and students.

£1-80

Most Books described here are American in origin.

The above prices include postage & packing.

Delivery is from stock.

Available from

Publications Dept., 55 Victoria St., London S.W.1.

(Counter Service, 9.30-5.15, Mon. to Fri.)

SHORT WAVE MAGAZINE

01-222 5341

(Nearest Station: St. James's Park)

(GIRO A/C. No. 547 6151)

PRACTICAL INTEGRATED CIRCUITS

This is the first British book to be published on micro-electronics for the amateur experimenter. With circuit diagrams, layouts and easy instructions, it shows how to construct ten practical radio and electronic devices using integrated circuits (IC's) which are now available at low cost from many component stores. Micro-electronics—the big development in electronics since the transistor—involve complex circuits in the form of tiny "chips", incorporating several circuit elements, to which it is only necessary to make connections. Various kinds of micro-circuits are already available to amateurs, with new ones regularly coming on to the market. In this book the authors provide, in addition to practical projects, an introduction which shows clearly the present state of the art and a summary of the items available commercially. The advent of the integrated circuit (IC) opens up a fascinating new field for the electronics student, constructor and experimenter. This book shows how to get started and produce some really interesting and worthwhile equipment.

£1-01 post free

HANDBOOK OF TRANSISTOR CIRCUITS

By Allan Lytel

Here is a collection of more than 200 practical transistorised circuits for use in counters, power controls, timers, indicators, photoelectric devices, power regulators, amplifiers, power supplies, oscillators, power converters, and other applications. Schematic diagrams, parts lists and descriptions of operation are included for each circuit.

Planned as a supplement and companion volume to author Lytel's previous book, *Transistor Circuit Manual*, many of the circuits employ such specialised semi-conductor devices as silicon-controlled rectifiers, photocells, zener diodes, and tunnel diodes, in addition to standard diodes and transistors.

This book is a handy source of information on the design, operation, and application of a wide variety of transistorised circuits. Engineers, technicians, students, and hobbyists will all find the circuits of interest and the material of value in research, development, experiment, and general studies of circuitry.

£2-35 post free

PRACTICAL WIRELESS CIRCUITS

There are more than 50 different circuits detailed in this book. Transistor receivers, 22 in all, range from an ultra-simple crystal diode circuit to a very sophisticated 10-transistor communications Rx. Valve receivers cover MW, SW and FM. Transistor and valve amplifiers include preamplifier, PA and Stereo.

There is a chapter on transmitters and transceivers, and another on transmitter and receiver circuits for Model Control. Circuits for an extensive range of Test Gear cover everything from a simple Transistor Tester to Comprehensive Multimeter, including a Pocket Signal Tracer (RF, AF and IF), also FM, Square-Wave and Noise Generators.

Among the special circuits are a recording level meter for tape recorders, an electronic photographic timer and a solar cell receiver.

The first few simple circuits are accompanied by step-by-step instructions to enable the absolute beginner to gain enough experience with circuitry building to tackle the more complicated work.

£1-34 post free

49 EASY TRANSISTOR PROJECTS

This book is for the electronic hobbyist who is interested in developing projects that can be fun as well as useful. Most projects can be constructed in one evening using only a few inexpensive parts. Many of the parts can be salvaged from old radio and television chassis.

Each project is presented in an easy-to-understand way, with a parts list and a schematic diagram. Many value substitutions can be made in resistors and capacitors without affecting the end result, providing that the proper transistors, coils, and transformers are used.

Projects in this book, which include an AM radio, an FM receiver, light relay controls, audio amplifiers, code practice oscillators and test equipment—each designed with only two transistor types.

£1-01 post free

110 SEMICONDUCTOR PROJECTS

Due to the rapid advances in semiconductor technology, many engineers and certainly most amateurs have found it impossible to keep track of the new devices that become available because of lack of readable information. This book introduces the reader to such outstandingly useful new devices as the field-effect transistor, uni-junction transistors, silicon controlled-rectifiers, silicon planar transistors and integrated circuits, giving their properties and methods of operation, with full constructional details of many exceptionally useful circuits.

Of particular interest to the amateur are simple amplifiers, lamp and relay driving circuits, electronic switches—operated by light, sound or contact with water—and delay circuits ranging from a fraction of a second to 35 minutes. Among the many circuits which will be of interest to the practising engineer are amplifiers with input impedance as high as 500 megohms, voltage and current regulators, waveform generators, analogue-to-digital converters and logic circuits. All circuits are designed around internationally available semiconductors.

124 pages, including 110 illustrations

£1-37 post free

Radio Shack Ltd ★

London's Amateur Radio Stockists

Just around the corner from West Hampstead Underground Station

Drake has made The Best better!

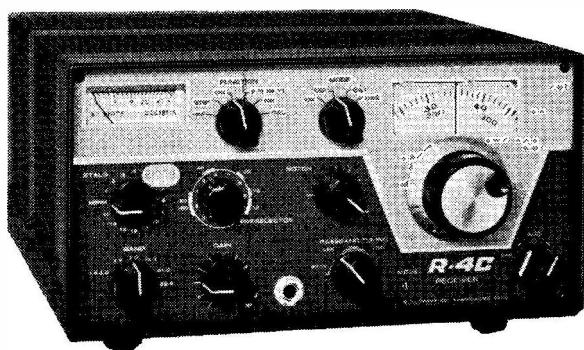

The New **DRAKE** **R-4C** **Receiver**

FEATURES

- Solid State Linear permeability-tuned VFO with 1 kHz dial divisions. Gear driven dual circular dials. High mechanical, electrical and temperature stability.
- Covers amateur bands with crystals furnished. Covers all of 8,040, 20 and 15 metres, and 28.5-29.0 MHz of 10 metres.
- Covers 160 metres with accessory crystal. In addition to the amateur bands, tunes any fifteen 500 kHz ranges between 1.5 and 30 MHz. 5.0-6.0 MHz not recommended. Can be used for MARS, WWV, CB Marine and Shortwave Broadcasts.
- Superior selectivity: 2.4 kHz 8-pole filter provided in SSB positions. 8.0 kHz, 6-pole selectivity for AM. Optional filters of .25, .5, 1.5 and 6.0 kHz bandwidths available.
- Smooth and precise passband tuning.
- Tunable notch filter attenuates carriers within passband.
- Transceive capability. May be used to transceive with the T-4X, T-4XB or T-4XC Transmitters. Illuminated dial shows which PTO is in use.
- USB, LSB, AM and CW on all bands.
- AGC with fast attack and two release times for SSB and AM, or fast release for break-in CW. AGC also may be switched off.
- New high efficiency accessory noise blanker that operates in all modes.
- Crystal lattice filter in first IF prevents cross-modulation and desensitisation due to strong adjacent channel signals.
- Excellent overload and intermodulation characteristics.
- 25 kHz calibrator permits working closer to band edges and segments.
- Scratch resistant epoxy paint finish.

DRAKE — SALES — SERVICE

SECURICOR ★ COURIER EXPRESS ★ B.R.S. ★ ACCESS ★ BARCLAYCARD ★ U.D.T.

RADIO SHACK LTD.

OPEN 6 DAYS 9 — 5 CLOSED 1 — 2 p.m.

**188 BROADHURST GARDENS
LONDON, NW6 3AY**

Just around the corner from West Hampstead Underground Station

Telephone: 01-624 7174 Cables: Radio Shack, London, N.W.6.
Giro Account No.: 588 7151

LOWE ELECTRONICS

119 Cavendish Road, Matlock, Derbyshire, DE4 3HE

Tel. Matlock 2817 or 2430 9 a.m. - 9 p.m.

John: G3PCY

Bill: G3UBO

Alan: G3MME

Hours : Tuesday to Saturday 9-5.30 (closed for lunch 1-2 and all day Monday).

Service and Sales : A good range of our equipment is available (evenings and weekends only) at the following : John G3JYG, 16 Harvard Road, Ringmer, Lewes, Sussex. Tel : Ringmer 812071. Sim GM3SAN, 19 Ellismuir Road, Baillieston, Nr. Glasgow. Tel : 041-771 0364. Alan GW3YSA, 35 Pen y Waun, Efail Isaf, Nr. Pontypridd, Glam. Tel : Newton Llantwit 3809. Peter Ward G3XWX, 47 Radstock Avenue, Ward End, Birmingham, B36 8HD.

Service only (evenings and weekends) : Dave Dryden G3BKQ, 205 Main Street, Thornton, Leics.

MAIN DISTRIBUTORS FOR YAESU MUSEN EQUIPMENT

In view of the uncertainty of prices and VAT and as the pre-VAT mad rush to buy has died down, it might be a good time to advertise some of our lesser-known bits and pieces, and at the same time, as well as advertising them, see if we can't give you some helpful hint and tips.

Yaesu News

FT101 owners—we now have AM filters in stock—indispensible for the 2m. ma. Price £18 + VAT. Write for details of fitting or arrange a day when we can do it.

FTdx401 owners—we thoroughly recommend our tune-up device which requires 9 volts and plugs into the mike socket. This is a high output pulsed tone of 10 millisees. on and 50 millisees. off. This 20% duty cycle means you can load up your FTdx 401 (or any other 55B rig) at full power to achieve optimum loading conditions without over-running the P.A. Using this device we have run an FTdx 401 at FULL POWER for an hour without the slightest sign of distress. We are very pleased with this little idea and anyone running high power (particularly applicable to linears) will find it invaluable. For blind or handicapped operators—this is the answer. We like it, and at the price of £1.50 + VAT for a kit, or £3.00 + VAT assembled on a P.C. board, it represents a worthwhile addition. However, please note two very important points—one—it does not absolve you from treating your rig to a 50 ohm (or about) antenna and—two—please don't load up right on top of a QSO. The poor chap struggling to copy a weak signal will swear at us, not you!

Mobile News

We still have a few FT75's at pre-revaluation prices, so if you are thinking of a mobile rig, the FT 75 fits into the smallest of cars and gives a very good account of itself both for local and DX working. There is a great deal to be said for a compact, trouble free, push button rig for mobile—it looks good and it PERFORMS.

Station Accessories

The uncertainty of import prices gives us a chance to advertise the station accessories which we have in stock and which we rarely get a chance to describe in any detail.

Aerials

We always have a wide selection in stock ranging from 4 element wide spaced single beam, three quads and verticals to 2m Yagis and 2m. whips. For the man who wants a big beam—give us a yell, because we generally find that, price for price, our Japanese beams out-perform all others in quality and performance. In the medium price range we find the American Polygon quad a good buy and in the lower price range our verticals take some beating.

Asahi Echo 8G

Here is a trap vertical requiring no guys and no radials (although radials can give greater performance) covering 40m. to 10m. with a low SWR at a very low price of £20 (+VAT) including carriage. It stands about 21ft. high and is an excellent performer.

Diamond DP 104

A compact trap vertical for 20, 15 and 10m. Low SWR on all bands and only stands some 11ft. high. Excellent for portable or where neighbours are a nuisance. £19 + VAT carriage paid.

Diamond DP 103

80 and 40m. trap vertical about 25ft. high. Light guying advisable (ropes provided). My own feeling is that an 80m. dipole will outperform an 80m. vertical, but if you haven't room for a dipole, then the DP103 will work well for you. Radials not essential, but they always help. Tune for the bit of the band you use most, but remember that, as with ALL loaded verticals, tuning is fairly sharp. Price £25 + VAT carriage paid.

Diamond DP 105

Covering all bands 80 to 10, standing about 25ft. high and again benefiting from light guying (provided). A popular antenna for the man who hasn't room for an 80m. dipole. Price £35 + VAT carriage paid. In connection with the above aerials, the questions we are mostly asked are:—

1. Do I need an ATU ? No, definitely not.
2. Do I need radials ? No, provided the vertical is post mounted at ground level, but radials do improve performance and if you can lay them out it isn't a bad idea.
3. Can I mount it on a chimney ? Yes you can, but here radials are essential.
4. What coax does it need ? Coax straight from the Transmitter into the aerial—ideally 50 ohm but 75 ohm won't harm anything.

All in all, the vertical is probably the easiest to erect, easiest to tune for lowest SWR and least likely to attract any of all Amateur aerials, and the performance, while not up to a good beam or quad, is surprisingly good.

Mobile Aerials

We stock the very popular G-whip range amongst which are the Tri-lander, multi-mobile and, a new product, the Flexiwhip which has a coil spring built in. These are all-band mobile whips featuring helical loading on the H.F. bands with centre loading on the L.F. bands. The Multi-mobile has the advantage of up to 4 band operation without coil changing—requires patience in tuning, but once tuned for the desired bands, requires no coil changing or switching—simply switch the transmitter to the desired band. For portable operation, the "extends rod" can be used to increase the whip length for better performance without

appreciably altering the point of resonance . . . If you can't work him on the move, pull over to the side, add the "extendarod" and try again !

For the L.F. Mobileer—the 160/80m. or Ranger 160 is a good buy.

G-Whip Prices—Carriage (50p) + VAT extra.

Tribander (20, 15 & 10) £10.50 Multimobile (20, 15 & 10) £12.50.

L.F. Coils (40, 80 and 160m.), £4.00. Top whip sections, £1.00.

Duo-bander (80/80m.), £9.00. Ranger 160m., £8.00.

Flexiwhip, £15.00. Coils, £4.00 each.

Base section for all G-Whips, £1.50. Extendarod, £4.80.

Please note that carriage and VAT are EXTRA.

V.H.F. antennas

We stock a good range of 2m. "J" Beams from the simple 4 element up to the Farabeam and 8 over 8. We have them in stock and can ship either British Rail Express (50p extra) or by Securicor 24 hour service (£2.00 extra). We have both 50 and 75 ohm versions, so please advise us which you want.

"J" Beam Prices + VAT + Carriage.

2/4 element, £2.90

2/8Y 8 element, £4.20

2/14P 14 element Farabeam, £14.30

2/16 Double 8 slot fed, £8.40

2/10XY Crossed 10 element, £12.20

Please add VAT and Carriage.

2m. Mobile Whips

We consider the Diamond 3 vertical gutter mounting whip to be a best buy. A beautifully finished antenna, mounted in seconds, which requires no holes or other mods to the vehicle. Complete with 4m. coax. Very flexible—drive straight into your garage. Considering the performance, quality and finish of this antenna, the price is very reasonable at £10 plus VAT. Carriage 50p.

Antenna Accessories

SWR Meters

Probably the most important accessory in the shack—we stock two models—the well known and very popular Hansen SWR 3 and the twin meter Asahi. The Hansen has a single meter which is switched to read forward or reflected power, and has a sensitivity pot which enables it to be used with a wide variety of rigs of different power outputs. It gives a useful reading on as low as 160m. and as high as 2m. Price £5 + VAT, post paid.

The Asahi has the advantage of twin meters so that both forward and reflected power may be monitored simultaneously. It also has a sensitivity pot and is useful from 160 to 2m. Price £8 + VAT, post paid.

Both the above are of 50 ohm nominal impedance, but may be altered to 75 ohms by simply substituting 100 ohm resistors for the 150 ohm resistors fitted.

Coax sockets in both cases are SO 239 as fitted to all Yaesu gear and require PL259 plugs which we can supply at 30p (plus VAT) each post paid. If you use 1" coax (UR43 or similar) we can also supply PL259 reducers at 10p each (plus VAT), post paid.

One or two points which you may find interesting. When your SWR meter reads 1 : 1 you may have a perfect match, but try and bear in mind the following:—

1. The diodes used in any Amateur type SWR meter require a certain voltage across them before they conduct, so that your apparent 1 : 1 SWR may be due to the diode nearly, but not quite, conducting. Hence you should always momentarily check your SWR at a higher power. (No need to wreck the PA—just sufficient to check SWR).

2. The coax cable you are using has losses. Take a look at the table of losses below and consider that with 150 feet of nice new UR 70 on 10m., the forward power drops off 3.9 dB by the time it reaches the antenna. By the time the reflected power gets back to the SWR meter, it has dropped another 3.9 dB. Hence there is a built in 7.8 dB differential between forward and reflected power. This means, of course, that even if your 10m. aerial has blown away, your SWR meter will still read around 2.5 : 1 which could thoroughly bamboozle you ! It is instructive to stick a 2m. Yagi at the end of a long length of coax—check the SWR. Remove the Yagi and check again. You may get quite a surprise !

The moral to this tale is—use the SWR meter as a guide but be aware of its limitations.

When you first put up an antenna, it makes sense to plot the SWR on graph paper, starting at one end of the band and taking readings every 25 kHz on 80 and 40, every 50 kHz on 20 and 15 and every 100 kHz on 10. This way you can see where your lowest SWR occurs and, if that point isn't where you want it, you can bring it where you want it by lengthening or shortening the elements. On multi-band antennas—adjustment on one band can affect the others so keep on checking all bands until you get an acceptable compromise.

V.H.F. SWR Meters

Inductive and capacitive reactance which at H.F. is negligible, becomes a nuisance on 2m. and renders the normal SWR meter a bit suspect. It also, in the case of many modern 2m. transceivers with PA protection, causes the PA to cut off due to the slight added reactance being just sufficient to operate the protection circuit. We are therefore importing a new SWR meter specifically designed for 2m. and 70 cms. Not unfortunately more expensive than the H.F. variety, but not too out of the way at £14 plus VAT, post paid.

Cable

We stock :-
UR43 8p/m. plus VAT
UR73 1p/m. " "
UR67 22p/m. " "
75 ohm twin feeder 3p/m.
300 ohm twin feeder 5p/m.

POSTAGE EXTRA. Please allow plenty and we'll refund the balance.

Choice of coax—for H.F. use, unless you are running high power, UR 43 (RG 58/U) or UR 70 is probably good enough assuming you don't have too long a run, but for V.H.F., for goodness sake get the best—it is false economy to save money on coax ! A short length of UR 43 is acceptable for mobile use, but for a Yagi on a mast you really ought to lash out on UR 67 (RG 8/U). This of course applies to receiving as well as transmitting antennas (unless of course you don't mind losing most of your signal in the coax !).

Cable Losses

You will find this table useful as a guide to choosing a cable.

	144	432
	MHz	MHz
	MHz	MHz

Cable	Nominal Impedance	Attenuation dB/100 ft.
UR67 Coax (RG8/U)	50 ohms 0.3	0.45 0.66 0.83 0.98 2.5 4.8
UR43 Coax (RG58/U)	50 ohms 0.68	0.00 1.5 1.9 2.2 5.7 10.4
UR70 Coax	72 ohms .80	1.17 1.76 2.23 2.6 6.7 12.2
75 ohm twin	75 ohms .31	.52 .88 1.23 1.5 5.1 8.2
300 ohm twin	300 ohms .21	.33 .48 .61 .71 1.82 3.29

The obvious lesson to be learnt from this is that the most expensive coax can work out to be the cheapest in the long run. It is also pretty obvious that the use of a balun and twin feeder can work out cheaper and more efficient (see under "Baluns").

Rotators

We stock the well known CDR range which for years have been used by Amateurs all over the world. AR22-R, £25 + VAT; TR44, £45 + VAT and HAM-M at £70 + VAT. All complete with remote indicator/control box and carriage paid by Securicor.

Choice of Rotator

The number of chaps who use an AR22 to turn a hefty H.F. beam is legion. It is a tribute to the ruggedness of the AR22-R that they get away with it for so long—but sooner or later the gears strip. The fact is that the AR22-R is designed for 2m. beams. For something bigger, up to light 3 element trap beams (TA 33 jnr. for example) the TR 44 is the shot. For the heaviest of beams, the extra ruggedness of the HAM-M ensures a long trouble-free life. At Matlock we use a Ham M—it has been on top of the tower for many years and will remain there for many years to come !

Rotator Cable

Four core for the AR22-R at 15p/metre and 12 core for the TR44 and Ham-M at 30p/m. Actually the latter two require a rather odd cable—8 core, two cores of which are 18 ga. and the remaining 6 are 22 ga. This cable will allow operation up to about 50 yards away. A special cable like this costs rather a lot, so we sell standard 12 core and parallel 2 lots of 3 wires to give the required extra thickness. The cable we sell is well on top of the requirement—can be used for remote operation well in excess of the claimed 50 yards.

Baluns

A balun transforms the unbalanced output of a transmitter into a balanced output suitable for loading inherently balanced antennas. As all dipoles and the majority of beams and quads fall into this category, it makes good sense to use a balun. It is not, of course, essential to do so, but we feel that the return on a small outlay makes it very well worth while. In the case of an 80m. dipole for example, I can't help feeling that there is everything to be said for making a folded dipole out of 300 ohm ribbon and feeding it with 300 ohm ribbon in conjunction with a 4 : 1 balun at the transmitter. The advantages of a lower line loss and, more important, broader band width make it really attractive. The only snag being that 300 ohm line is possibly more antisocial than a single, barely visible wire. Another way 300 ohm line can be used to advantage is by using it to feed your beam. Provided the length of 300 ohm line is a half wave length or multiple of half wavelength it can be used to feed a dipole, beam, quad, or trap dipole very successfully. Bearing in mind its velocity factor of about 0.8, a length of about 55 feet is a wave length on 20 m., 11 on 15m. and 2 wavelengths on 10m. The losses in 55 feet of 300 ohm ribbon are negligible as is the cost. In this case of course you must use a 1 : 1 balun at the transmitter. If you want even lower losses and even lower cost, make your own 600 ohm open wire feeder, but this time forget the velocity factor. A smart thing to do is to start off with the feeder about 5 feet too long and trim it until the SWR is respectable on all bands.

Looking back at the bit on SWR meters—I mentioned that due to line losses, the measured SWR could be very optimistic indeed. Replacing lossy coax with some low loss twin feeder may show you what your SWR REALLY is. Blame the twin feeder if you like, or blame me, but much better to get your antenna SWR respectable ! Having done this your friends won't believe that you're still running barefoot.

Balun Prices

Popular H2P balun 1 : 1 ratio is £4.80 + VAT, post paid.
H2P balun 4 : 1 ratio is £4.80 + VAT, post paid.
Rugged Kirk 5075 B 1 : 1 2 kW broad band £7.50 + VAT, post paid.
Kirk 5075 D LF 1 : 1 2 kW specially optimised for 160, 80 or 40m. dipoles £7.50 + VAT, post paid.

Talking of antennas generally we should perhaps mention that we are firmly of the opinion that as the modern transmitter requires a 50 ohm or thereabouts antenna, it makes sense to load directly or via a balun into such an antenna.

We do not like the alternative of trying to make a high impedance

antenna (long wire, G5RV, Windom, etc.) look like 50 ohms by means of a Z match or A.T.U. Experience shows that by and large P.A. troubles stem from high impedance antennas—and you, these troubles can and usually are overcome with experience. But why invite trouble when it isn't necessary?

In the case of antennas for receiving only, much of what I have said does not apply. On the contrary, a long wire (as long and as high as possible) in conjunction with an ATU takes a lot of beating for receiving. It has the great merit of low cost and simplicity, and the improvement in reception by the addition of an ATU (preferably home made from one of the many designs extant) is well worth it. Nothing to stop the listener buying a transmitting antenna, but there is really no necessity to go and spend a lot of money, because the improvement in reception is not proportional to the cost.

Wattmeters

This is the final item I'd like to mention in connection with antennas. This is a properly terminated dummy load/wattmeter, aimed at the serious VHF man—it is a direct reading wattmeter with a constant 50 ohm impedance right up to 500 MHz making it ideal for power measurements at 2m. and 70 cms. Switched scale 20 or 120W f.s.d. and the large log scale makes low power readings possible to less than 500 mW. If you are H.F. only, forget it—you can get a dummy load much cheaper, but a 2m. or 70 cm. dummy load is a very different matter. Add to this the fact that the signal and the sum becomes objectionable, then you must agree that it is very well worth £35 plus VAT.

Microphones

We stock the well known Yaesu YD844 table mike at £13 plus VAT and the even more widely known YD846 hand mikes at £5 plus VAT. These are both 50K dynamic with PTT and fitted normal 3 contact jack plug. They plug into all Yaesu gear which is not already provided with a mike.

Headsets

In common with everybody else, the headsets we sell are the universal low impedance padded stereo Hi Fi sets. The reason we don't sell proper communication headsets is that they cost rather a lot of money and the stereo sets, due to mass production and mass marketing, represent much better value for money. However, all the stereo sets on the market suffer from two snags for Amateur use :-

1. They are stereo
2. They are very sensitive

They can be converted to monaural by simply chopping off the lead going to the chassis on the stereo plug, and substituting the lead which goes to the ring. The fact that they are very sensitive means that unless the A.F. gain control is turned right down, it will take the top of your head off. The snag is that with the AF gain right down, residual hum tends to be a real nuisance and this hum becomes objectionable. The cure is simple—an attenuator, consisting of just two small resistors—a 10 ohm across the plug of the headset and a 100 ohm in series with the signal lead. Having done these simple mods the headsets become really good for Amateur use. Good quality sound and very comfortable to wear. Full instructions in detail with sketches, on the above modifications with every set. Price £3, post paid + VAT.

Valves

For common valves like 6BA6's, 6BE6's, 6AU6, etc., etc., we recommend you go to one of the large London dealers in valves—we simply cannot compete with their prices. Honestly if we want a common valve, we get it from RST or Z & I rather than go to our Wholesaler—it's cheaper. We recommend you do the same.

Where we can be of service to the Amateur is to stock some of the valves he can't get easily, particularly those used in Yaesu equipment as under :-

6AH6, 6BZ6, 6CB6A, 6CL6, 6UBA, 6EW6, 6EH7, 6BM8, 12BY7A.
All at 60p each + VAT, post paid. 6GK6, £1.20 + VAT, post paid.
PA Valves 6JM6A, £1.50 each + VAT, post paid.

6J56C, 6KD6, £2.00 each + VAT, post paid.
These are supplied in matched pairs at no extra cost.
Finally we must mention that we still have some 4CX250 valve bases in stock complete with chimneys. Brand new £3 plus VAT, post paid.

Service

Ask anyone who has dealt with us—he is our best advertisement.

Second Hand Equipment

We always have the best selection in the best condition, fully checked, serviced and guaranteed. If it is not to your liking, you simply pick up the 'phone and tell us. We collect and you get your money back less the cost of carriage. This takes all the risk out of buying second-hand. A S.A.E. will get you our latest second-hand list and a large envelope with a 6p stamp on will get you our complete catalogue which runs to over 50 pages, and includes circuit diagrams of all new gear.

Trade-Ins

We are always happy to trade in used equipment if it is something we can recommend to another customer. We don't mind if it's faulty because we service all the second hand gear before resale anyway.

Hire Purchase

We can arrange Hire Purchase terms on both new and second hand gear. The deposit is a mere 10% and repayment may be spread over 12, 18, 24 or 36 months. Your trade-in gear is perfectly acceptable as a deposit.

Agents

Don't forget that our Agents, Sim, in Glasgow, John in Sussex, Alan in S. Wales, and Peter in Birmingham can demonstrate and supply Yaesu gear, have second-hand gear for sale, have a wide range of accessories and are available evenings and weekends to help you, advise you or just chat to you. Why not 'phone them if you have any problems?

In the case of Peter in Birmingham, he is operating full time from his home and although not yet on the 'phone is available pretty well any time. Five minutes from the Gravely Hill interchange (Spaghetti Junction) put him pretty close to you.

LOWE ELECTRONICS

119 CAVENDISH ROAD, MATLOCK, DERBYSHIRE, DE4 3HE

Tel. MATLOCK 2817/2430

MEMBERS OF THE AMATEUR RADIO RETAILERS ASSOCIATION



ANNOUNCE

A NEW SERVICE

JUST PHONE YOUR ORDER IN!

NO LETTER WRITING — NO MONEY REQUIRED — JUST QUOTE YOUR ACCESS CARD NUMBER AND WE DESPATCH THE GOODS!

This service will be available to callers, mail and telephone customers ; just another part of the finest service available to the U.K. Amateurs. We hope you'll give it a try ! We'll despatch your order the same day if humanly possible by whatever means you wish.

You may order anything which we sell by this high speed service, including used equipment, up to the limit of your Access card.

NOW IS YOUR LAST CHANCE!

Don't forget all prices go up by 10% V.A.T. in April on everything which we sell except Caslon Clocks. You'd be wise to make that possible change in your station now !

H.P. With inflation and V.A.T. you may as well get the goods on H.P.!

EXAMPLES OF HIRE PURCHASE
Monthly Repayments over :

Model	Deposit	1 Year		H.P. Price	1½ Years		H.P. Price	2 Years		H.P. Price	3 Years		H.P. Price
FR50B	£7-00	5-£6 ; 7-£5	£74-00	16-£4 ; 2-£3	£77-00	2-£4 ; 22-£3	£81-00	11-£3 ; 25-£2	£90-00				
FR400SDX	£16-00	6-£14 ; 6-£13	£178-00	9-£10 ; 9-£9	£187-00	12-£8 ; 12-£7	£196-00	18-£6 ; 18-£5	£214-00				
FT1FT75	£12-50	3-£11 ; 9-£10	£135-50	3-£8 ; 15-£7	£141-50	16-£6 ; 8-£5	£148-50	6-£5 ; 30-£4	£162-50				
FTJFF200	£18-00	5-£15 ; 7-£14	£191-00	3-£11 ; 15-£10	£201-00	1-£9 ; 23-£8	£211-00	32-£6 ; 4-£5	£230-00				
FT-101	£26-00	6-£22 ; 6-£21	£284-00	2-£16 ; 16-£15	£298-00	22-£12 ; 2-£11	£312-00	27-£9 ; 9-£8	£341-00				
FT-401	£23-00	5-£20 ; 7-£19	£256-00	12-£11 ; 6-£13	£269-00	19-£11 ; 5-£10	£282-00	33-£8 ; 3-£7	£308-00				
FT-2FB	£9-00	7-£8 ; 5-£7	£100-00	6-£6 ; 12-£5	£105-00	6-£5 ; 18-£4	£111-00	4-£4 ; 32-£3	£121-00				
FT-2 AUTO	£15-00	3-£13 ; 9-£12	£162-00	12-£9 ; 6-£8	£171-00	20-£7 ; 4-£6	£179-00	36-£5 ; 3-£4	£195-00				
YC-305	£9-00	2-£8 ; 10-£7	£95-00	1-£6 ; 17-£5	£100-00	1-£5 ; 23-£4	£106-00	35-£3 ; 1-£2	£116-00				
YC-305D	£12-00	4-£10 ; 8-£9	£124-00	11-£7 ; 7-£6	£131-00	6-£6 ; 18-£5	£138-00	31-£4 ; 5-£3	£151-00				
FL-2100	£15-00	6-£13 ; 6-£12	£165-00	14-£9 ; 4-£8	£173-00	22-£7 ; 2-£6	£181-00	3-£6 ; 33-£5	£198-00				

REMEMBER! THE YAESU RANGE IS SECOND TO NONE & LIKE OUR SERVICE !

- SPARES:** We carry a full stock of factory recommended spares and more besides!
- SERVICE:** We do all labour FREE on warranty claims.
- GUARANTEE:** We maintain the YAESU 12 months guarantee.
- DELIVERY:** We deliver within 24 hrs. of receipt of order of items which are in stock. This is the **fastest delivery service in the country** and costs £1 per parcel only ! 48 hr. service to Scotland and remote places.
- COLLECTION:** In the unlikely event of your having faulty equipment, all you have to do is phone/write us and we will collect by SECURICOR AT OUR EXPENSE and return the unit to you AT OUR EXPENSE.

YAESU PRICES

Due to the currency changes the above H.P. prices and those quoted below will apply to current stocks only. New stocks will have to be charged at the new prices to be determined. V.A.T.—avoid delay by adding the V.A.T. % to your order.

FT-101 Mk. I Ex-stock £229 + V.A.T. NO PRICE INCREASE
NEW FT-501. We regret delivery has been delayed and these will not now be available until June. Due to the revaluation of the yen our special offer cannot apply.

TEMPO 2 METRE FM AMPLIFIERS

Model	Drive Power	Output Power	Current	Price
1002-3	5-25 watts	100-135 watts	17 amps	£119.97
802	5-12 watts	70-90 watts	12 amps	£98.90
502	5-15 watts	35-55 watts	5 amps	£57.95
TCP 12A	Control Head			£17.85

All the amplifiers operate on 13.8v. D.C.

NEW! 2m. SSB-FM POWER AMPLIFIER, SEIDENSHA FMB200J

- ★ 100w Output
- ★ Supplies 12v. DC regulated for FT2F etc.
- ★ 10w. Drive only.
- ★ Operates on AC mains.

Price £160

NEW/USED EQUIPMENT

Collins 75S1, v. good ...	£175-00	KW2000 + AC + DC PSU ...	£150-00	Pyramid Linear	£37-00	Trio 9R59D	£30-00
Codar pre-selector ...	£5-00	KW2000A + AC PSU ...	£149-00	Lafayette HA350	£55-00	Trio 9R59DE	£30-00
Eddystone EC10 Mk. 2 ...	£60-00	KW2000B + AC PSU ...	£170-00	Lafayette HA500	£30-00	Trio 9R59DS	£39-00
Eddystone 750	£45-00	KW DC PSU for 2000A ...	£20-00	Lafayette HA600	£39-00	Trio 9R59DS NEW ...	£49.50
Eddystone 888A	£55-00	KW PEP Meter	£20-00	National NCX 5	£175-00	Trio JR500SE	£45-00
Halicrafters, HT32B ...	£80-00	KW Viceroy 4	£80-00	Racal MA79G	£175-00	Trio JR310	£60-00
Hamgear Pre-selector ...	£6-00	KW 201	£10-00	Sommerkamp, FT-100 + 160m. ...	£485-00	Trio TS510	£140-00
Heath SB200, mint ...	£99-00	KW Atlanta, NEW ...	£75-00	Sommerkamp, FT-250 ...	£150-00	Trio JR310	£199-00
Heath SB303 NEW + cw ...	£238-00	KW Atlanta, used ...	£199-00	Sommerkamp, FT-500 ...	£135-00	Yaesu FT-101 + 160m. ...	£205-00
Heath SB303, mint ...	£150-00	KW Vespa 2	£90-00	Tristao 105' Telescopic tower	£225-00	Yaesu FT-200	£140-00
Heath SB101 + HP23E ...	£150-00					Yaesu FT-560	£155-00
Heath HW32A + HP23E ...	£60-00						
Heath Mohawk, 160-10 ...	£59-00						

- ★ Your "one stop" single source for masts, towers, rotators, antennas
- ★ Largest stock range in the U.K.
- ★ Money-saving packaged deals.



HY-GAIN (Ex-stock, Carr. paid)

HY-GAIN

Whether you are : (a) simply short of space and don't want guys
or (b) require an efficient 10-80m. antenna

The answer is HY-GAINS 18AVT/WB (illustrated right)

Take the wide band, omnidirectional performance of Hy-Gains famous 14AVQ/WB add 80 mtrs. plus extra heavy duty construction and you have the new 18AVT/WB ★ True $\frac{1}{2}$ -wave resonance on all bands ★ 52Ω I/P ★ SWR of 2 : 1 or less at band edges ★ 1 kW (AM) ★ Radiation pattern has an outstandingly low angle ★ Roof or ground mounting.

Hy tower, 10-80m. (self-sup.)	£110.00
18V, 10-80m. vertical	£12.80
12AVQ, 10-20m. vert.	£16.50
14AVQ, 10-40m. vert.	£24.50
18AVT, 10-80m. vert.	£35.50
LC800, 8mm. coil for 14 AVQ	£7.75
TH6DXX, 10-20m. 6 ele. beam	£97.00
TH3MK3, 10-20m. 3 ele. 2 kW	£75.00
TH3 Jnr., 10-20m. 3 ele. 600W.	£51.00
Hy-Quad, 10-20m. 2 ele.	£74.50
BD10-15 10-15m. 3 ele.	£57.00
204BA, 20m. 4 ele. beam	£80.00
203BA, 20m. 3 ele. beam	£72.00
153BA, 15m. 3 ele. beam	£36.00
103BA, 10m. 3 ele. beam	£29.60
18TD, Resitape portable dipole	£41.00
LAI Lightning arrester	£14.50
LA2 Lightning arrester	£2.50

ROTATORS CDE and HY-GAIN

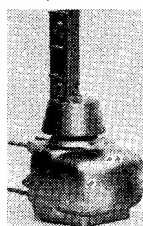

AR20



AR22

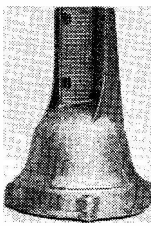

TR44



HAM-M



HY-GAIN 400

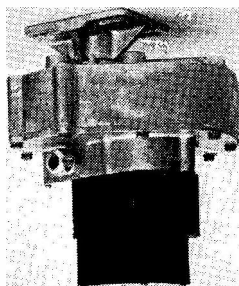

ALL ROTATORS Ex-stock

24/48 Hour Securicor delivery £1

We stock the best range of rotators, CDE and HY-GAIN and spares. Our stocks are good so you'll get fast delivery plus the after-sales service which counts.

AR20 This model replaces the old AR10 and is ideal for VHF beams, £20 (40p).

AR22R This model will turn HF antennas of TA33 Jnr. size and can be mounted on the top of masts up to 2 1/16" diameter or onto a flat plate. It can carry a deadweight of 150 lbs. Requires a 4-wire cable, £25 (65p).

TR44 This model is also for HF beams as the AR22R but carries a 500 lbs. load and has better braking. The control unit requires a 7-wire cable, £47 (75p).

HAM-M The best of the CDE range. Carries 1,000 lbs. deadweight for large HF beams and employs a solenoid operated brake. Requires an 8-wire cable, £70 (80p).

HY-GAIN 400. It's a brute but takes masts up to 3" dia. and automatically rotates to the desired direction by setting the compass control knob pointer as required. Mounts to standard tower plate on Versatower, £115.00

Note—All above rotators are ex-stock and delivery is normally EX-STOCK. All orders are despatched the same day as received.

ASAHI ANTENNAS

2m. Ground plane, 3-4 dB gain, AS-2HG, £9.65

BANTEX FIBREGLASS MOBILE ANTENNAS (Carr. 50p) including base (Ex Stock)

70 $\frac{1}{2}$, 70 MHz, $\frac{1}{2}$ wave ...	£3.00	BGA, 144 MHz, $\frac{1}{2}$ wave ...	£6.15	Magnetic mount ...	£6.15
144 $\frac{1}{2}$, 144 MHz, $\frac{1}{2}$ wave ...	£2.85	BS, 144 MHz, $\frac{3}{8}$ wave ...	£4.35	All aerials complete with base.	

G WHIPS (Carriage 50p Coils, 20p)

Tribander 10, 15, 20m. ...	£9.45	LF160 160m. coil ...	£7.50	160 Ranger ...	£7.40	MM80 80m. coil ...	£4.00
LF40 40m. coil ...	£4.00	Whip for LF coils ...	£1.00	Multimobile '71' 10, 15, 20m. ...	£12.50	MM160 160m. coil ...	£4.00
LF80 80m. coil ...	£4.00	160/80m. Duobander ...	£9.00	MM40, 40m. coil ...	£4.00	Basemounts ...	£1.45
						Extendarod ...	£.

GEM-QUAD. The best FIBREGLASS 10-15-20m. QUAD.

2 ele. ...	£74.50	3 ele. ...	£109.80	4 ele. ...	£144.00	Conversion kits ex-stock.
------------	--------	------------	---------	------------	---------	---------------------------

MOSLEY (Carriage paid) (Ex-Stock) from us for fast delivery

Mustang, 10-20m. 3 ele 2kW ...	£45.50	TA33 Jnr., 10-20m. 3 ele. ...	£36.50	TA32 Jnr., 'E' or 2" mast ...	£26.50
TA33 Jnr. 'E' for 2" mast ...	£37.00	TA32 Jnr. 1-20m. 2 ele. ...	£26.00	TA31 Jnr. Rotary dipole ...	£17.00

CATALOGUE—Communications equipment, antennas, towers, rotors, 20p.

Hours of Business : 9-5.30 p.m. Monday-Friday, 9-12.30 p.m. Saturday.

AGENTS : MIDLANDS —Andy Martin, G3UDR. Tel. Shipston-on-Stour 61839.
BUCKS. —Ian Partridge, G3PRR. Tel. Chesham 024-054143.

WESTERN ELECTRONICS (U.K.) LTD. TELEPHONE: TOTTON 4930 or 2785
OSBOURNE ROAD . TOTTON . SOUTHAMPTON CABLE: 'AERIAL, SOUTHAMPTON'

THE SENATOR CRYSTAL BANK

G3UGY

Phone 01-769 1639

CRYSTALS FROM STOCK AT KEEN PRICES

SENATOR CRYSTALS: the first place to contact when you need good crystals quickly.

Here are just a few of the popular frequencies actually in STOCK now:

kHz		MHz	
100 in HC13/U ...	£2.50	28-045 in HC25/U ...	£1.60
454 in HC6/U ...	£1.75	28-500 in HC25/U ...	£1.60
455 in HC6/U ...	£1.75	30-000 in HC6/U ...	£1.60
456 in HC6/U ...	£1.75	32-500 in HC18/U ...	£1.60
500 in HC6/U ...	£1.75	34-000 in HC18/U ...	£1.60
		34-500 in HC18/U ...	£1.60
		35-000 in HC18/U ...	£1.75
		35-500 in HC18/U ...	£1.75
		38-666 in HC18/U* ...	£1.35
		40-000 in HC18/U ...	£1.60
		42-000 in HC18/U ...	£1.60
		70-000 in HC18/U* ...	£2.00
		71-000 in HC18/U ...	£2.00
		72-425 in HC18/U ...	£1.75
		72-500 in HC25/U ...	£1.75
		72-525 in HC18/U ...	£1.75
		96-000 in HC18/U ...	£2.00
		116-000 in HC18/U ...	£2.80

* = Also in HC6/U

And here's our STOCK range of BRAND NEW HC6/U 8 MHz for 2M :
 8-002 8-007 8-012 8-018 8-021 8-0266 8-032 8-041 8-043 8-047 8-048 8-0555
 8-058 8-061 8-070 8-081 8-092 8-100 8-104 8-107

All at £1.25 each, post free.

The following frequencies may be suitable for your PYE Cambridge, Ranger, Vanguard, etc., etc. Check up with crystal multiplication data and crystal spec., in equipment manuals for suitability.

8-0555 MHz in HC6/U for TX x 18 =	145-000 MHz 2M Mobile	£1.25
44-7666 MHz in HC6/U for RX x 3 + 10.7 MHz =	145-000 MHz 2M Mobile	£1.80
8-100 MHz in HC6/U for TX x 18 =	145-800 MHz for RAEN	£1.25
45-0333 MHz in HC6/U for RX x 3 + 10.7 MHz =	145-800 MHz for RAEN	£1.80
12-975 MHz in HC6/U for RX x 12 =	10.7 MHz	
	145-000 MHz 2M Mobile	£1.60
11-1916 MHz in HC6/U for RX x 12 + 10.7 MHz =	145-000 MHz 2M Mobile	£1.60
12-0833 MHz in HC6/U for TX x 12 =	145-000 MHz 2M Mobile	£1.60
8-7825 MHz in HC6/U for TX x 8 =	70-260 MHz 4M Mobile	£1.60

29-780 MHz in HC6/U for RX x 2 + 10.7 MHz =	70-260 MHz 4M Mobile	£1.65
6-74666 MHz in HC6/U for RX x 12 =	10.7 MHz	
	70-260 MHz 4M Mobile	£1.60
11-710 MHz in HC6/U for TX x 6 =	70-260 MHz 4M Mobile	£1.60

NEW FREQUENCIES FOR POPULAR CHANNELS :

44-593333 MHz in HC6/U for RX x 3 + 10.7 MHz =	144-480 MHz F.M. Channel	£1.80
45-016667 MHz in HC6/U for RX x 3 + 10.7 MHz =	145-750 MHz Repeater Out	£1.80
8-063888 MHz in HC6/U for TX x 18 =	145-150 MHz Repeater In	£1.65
4-031944 MHz in HC6/U for TX x 36 =	145-150 MHz Repeater In	£1.65
4-027777 MHz in HC6/U for TX x 36 =	145-000 Mobile	£1.65
4-013333 MHz in HC6/U for TX x 36 =	144-480 MHz F.M. Channel	£1.65

NEW FREQUENCIES now available :

1-6202 MHz and 1-6184 MHz in HC6/U (spacing 1.8 kHz) at	£1.80 each
33-6666 MHz in HC6/U ...	£1.60
43-333 MHz in HC18/U ...	£1.70
46-666 MHz in HC18/U ...	£1.70
47-333 MHz in HC18/U ...	£1.70
48-333 MHz in HC18/U ...	£1.70
58-000 MHz in HC18/U ...	£1.70
10-86667 MHz and 9-975 MHz in HC6/U (TX/RX crystals) for glider channel 130-400 MHz at ...	each £1.70

Frequencies for specially manufactured SENATOR Crystals are as follows (made to Ministry of Defence Standards):

50—149.9 kHz in HC13/U ...	£4.60
150—499 kHz in HC6/U ...	£3.85
450—500 kHz in HC6/U ...	£3.50
501—999 kHz in HC1/U ...	£4.50
1-000— 1.39 MHz in HC6/U ...	£3.20
1.40 — 20.00 MHz in HC6/U (18/U & 25/U over 5 MHz)	£2.00
20.00 — 59.99 MHz in HC6/U ; HC18/U ; HC25/U ...	£2.25
60.00 — 79.99 MHz in HC6/U ; HC18/U ; HC25/U ...	£2.50
80.00 — 114.00 MHz in HC6/U ; HC18/U ; HC25/U ...	£3.00
114.00 — 140.99 MHz in HC6/U ; HC18/U ; HC25/U ...	£7.00
141.00 — 175.99 MHz in HC6/U ; HC18/U ; HC25/U ...	£8.75
176.00 — 200.00 MHz in HC6/U ; HC18/U ; HC25/U ...	£12.00

V.A.T. ADD 10% TO ALL PRICES. APRIL 1st ONWARDS —

Mail Order SENATOR CRYSTALS Dept. S.W., 36 Valleyfield Road, SW16 2HR

Latest FT-101 Transceivers, and full range of equipment from Stock. Checked (and adjusted where necessary) by experienced KW Engineers, before despatch. Your purchase of imported equipment is given professional care and attention. The most modern (and expensive) Test equipment in the Amateur Radio Trade, in this country, is available to our Engineers.

Usual KW courtesy and service. Easy terms available.

K.W. Developments Ltd.
 1 HEATH STREET, DARTFORD, KENT
 Telephone : Dartford 25574

G3ACQ OFFERS : CRYSTALS : 65p each.
YAESU MUSEN FT/FR50, FT 75 ; TRIO JR310, 9R59DS, TS515. J BEAMS ; HY-GAIN VERTICALS ; KATSUMI KEYERS — JUNKERS KEY — STOLLE ROTORS ; DIGITAL CLOCKS including tuning fork, battery operated types ; components.

S. MAY (Leicester) LTD.
 12/14 CHURCHGATE, CITY CENTRE,
 LEICESTER LE1 4AJ
 Telephone 58662

Our antennas are built around Stainless Steel hardware and heat treated alloy tubing for highest quality and value.

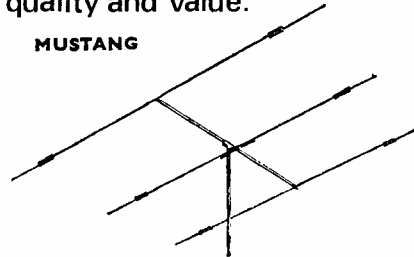

MUSTANG

FOR ALL ANTENNA DETAILS:
Send for complete Handbook, containing full details and prices of Antennas and other technical information. 25 pages, 15p

Refundable upon purchase of an Antenna.

ROTATORS, TOWERS
CABLES, INSULATORS ETC.

MOSLEY

Electronics Ltd

Administrative Address only
40 Valley Road, New Costessey, Norwich, Norfolk, NOR 26K

its a steal!

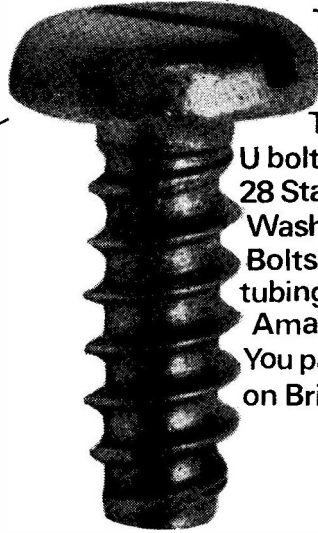

Take the 2KW Mustang you get

48 Stainless Steel Self Tappers, 8 Stainless Steel U bolts, 16 Stainless Steel Nuts 28 Stainless Steel Spring-Washers, 12 Stainless Steel Bolts together with traps tubing etc.

Amazing! all for **£48.40p**

You pay no extraneous costs on British Mosley Antennas

impact

R. T. & I. ELECTRONICS LTD.

where equipment is fully overhauled

KW VESPA 2 and p.s.u.	£105.00 (£3.00)
HEATHKIT GR 64	£25.00 (£1.00)
KW/GELOS CONVERTER (into 4.5 MHz)	£16.00 (50p)
LAFAYETTE HA350	£60.00 (£1.50)
LAFAYETTE HA800	£48.00 (£1.00)
HEATHKIT RAT	£35.00 (£1.00)
LAFAYETTE 80	£50.00 (£1.50)
HAMMARLUND SP-600-JX6	£135.00 (£2.00)
EDDYSTONE 770U	£160.00 (£2.00)
HEATHKIT DX 100 Transmitter	£45.00 (£3.00)
EDDYSTONE EC10 Mk. 2	£68.00 (£1.00)
KW 2000A with A.C. p.s.u.	£180.00 (£3.00)
NATIONAL NCX-5 with A.C. p.s.u.	£220.00 (£3.00)
TRIO TS 510 with A.C. p.s.u.	£150.00 (£3.00)
EDDYSTONE 960 Receiver	£120.00 (£2.00)
KW 201 Receiver	£90.00 (£2.00)
HEATHKIT RGI Receiver	£33.00 (£1.00)
TRIO JR-500-SE Receiver	£58.00 (£1.50)
RCA AR88D Receiver	£75.00 (£2.00)
TW 160 Communicator 12w. D.C.	£48.00 (£1.50)

WE CAN ALSO SUPPLY ANY MAKE OF NEW EQUIPMENT—and have pleasure in giving a few examples which are normally in stock:—

STOCKISTS OF YAESU MUSEN EQUIPMENT.

AVOMETERS, Model 7, Mk. 2, £37.60; Model 8, Mk. 5, £40.90; Model 9, Mk. 4, £40.90; Model 40, Mk. 2, £37.60; Model 72, £18.20; Multiminor, Mk. 4, £13.59; Standard leather carrying case (Models 7, 8, 9, 40), £6.50; Every-Ready dials, £7.40; Multiminor leather case, £3.30; 10KV D.C. Multiplier for Model 8 or 9, £6.10; 30KV D.C. ditto, £9.90; Pair of Long Reach Safety Clips, £1.50; Models EA113 Electronic Avo, £82.00. All above post free in U.K. Trade and Educational enquiries invited.

S. G. BROWN'S HEADPHONES, Type "P" 120 ohms, 2,000 ohms, 4,000 ohms, £5.90 (25p); Rubber earpads for same, 45p per pair (5p). Type 3C/1100 Noise excluding (with super fitting), high quality, electro dynamic, £7.50 (25p); Standard Jack Plugs, 24p (4p).

EDDYSTONE EQUIPMENT, Receivers, 8307, £389.00; EC10/2, £86.00; 1000, £210; 1001, £230; 1002, £193; 1004, £280; 924 A.C. mains p.s.u., £7.75 (50p); Doublet Aerial, 731/1, £7.50 (50p); Plinth Speaker, 906, £6.20 (50p); General Purpose Speaker, 935, £5.55 (40p); Edometer, 902 Mk. 2, £29.50 (50p); Telescopic Aerial, LP.3126, £2.50 (25p); Die-cast Boxes from 45p (10p). Brochure on request.

CODAR EQUIPMENT, CR70A, £27.50 (65p); PR30X, £9.50 (30p); PR40, £8.90 (30p); Leaflets on request.

LAFAYETTE HA600 Receiver £50.00 (50p).

LAFAYETTE HA800, £57.50 (50p).

NOTE: We request that from April 1st 10% VAT must be added to all prices, new & secondhand, inc. carr. & packing.
Carriage for England, Scotland and Wales shown in brackets.
Terms: C.W.O., Approved Monthly accounts are Purchase and Part Exchange. Special facilities for export.

At R.T. & I.

- ★ We have full H.P. facilities.
- ★ Part exchanges are a pleasure.
- ★ We purchase for cash.
- ★ We offer a first-class overhaul service for your electronic equipment, whether you are an amateur or professional user.
- ★ We have EASY Packing facilities.
- ★ We welcome your enquiries for specific items which although not advertised, may very well be in stock.

FREE SHURE MIC. WITH EVERY KW TRANSMITTER or TRANSCEIVER purchased

PARTRIDGE "JOYSTICKS", "New Lightweight VFA" £11.00 (40p).

"JOYMATCH" III, Aerial Unit, £11.00 (40p). LO-2500, £16.00 (40p); ATU kit, £4.50 (30p); ATU assembled, £5.50 (30p); Artificial earth £4.50 (30p); Aerial Bandswitch, £4.50 (30p). Literature on request.

TRIO EQUIPMENT, Receivers: 5R59DS, £49.50 (£1.00); JR 310, £75.00 (£1.00); JR 599, £185.00 (£1.50); Transmitter TX-599, £185.00 (£3.00); Transceiver TS 515 and PS 515, £210.00 (£3.00); Loudspeaker SP5D, £4.50 (50p); Headphones HS4 (equivalent), £6.00 (20p); Stabiliser, 60p (5p). Leaflets available.

SHURE MICROPHONES, 444T, £15.00 (40p); 444, £13.00 (40p); 401A, £6.50 (30p); 201, £5.40 (30p); 202, £6.00 (30p). Full details on request.

KEYNECTORS, piano key mains connector units, £2.95 (25p).

VALVES, Please state your requirements.

ADVANCE DMM2 DIGITAL MULTIMETER, £99.00 (50p), etc., etc

TMK METERS: TMK500, £9.00 (25p); TW20CB, £11.25 (25p); TP55N £6.25 (25p); 700, £18.00 (25p); also leather cases.

PHILIPS PM2403 ELECTRONIC MULTIMETER, £49.00 (25p), etc., etc

We also supply **PHILIPS and KORTING COLOUR TV TEST EQUIPMENT**, including Colour Bar Generators, Convertors, etc.

KW EQUIPMENT (Don't forget your FREE mic. with every Tx. and Txcrp.) KW2000B + A.C. p.s.u., £240.00 (£2.00); D.C. p.s.u. for KW2000B, £44.00 (50p); KW 2000B only, £200.00 (£1.50); KW2000E plus A.C. p.s.u., £265.00 (£3.00); KW ATLANTA + A.C. p.s.u., £190.00 (£2.00); Remote V.F.O. for Atlanta, £34.00 (50p); VOX unit for Atlanta, £7.50 (25p); Remote V.F.O. for 2000B, £36.00 (50p); KW1000 Linear amplifier, £135.00 (£1.50); KW202 Receiver with calibrator, £140.00 (£1.50); KW 202 Matching speaker, £8.00 (80p); KW204 Transmitter, £160.00 (£2.00); KW107 combined E-Z Match; VSWR indicator, dummy load, and ant. switch (4 outlets) 52 or 75 ohms, £46.00 (50p); KW103, VSWR and power meter, 52 ohms, £12.50 (45p); KW101, VSWR meter, 52 and 75 ohms, £8.25 (30p); also E-Z match, dummy load, trap dipoles etc., etc. Details on request.

R. T. & I. ELECTRONICS LTD.

Ashville Old Hall, Ashville Road, London, E11 4DX Tel: 01-539 4986

AMATEUR ELECTRONICS G3FIK

BIRMINGHAM 021-327 1497 021-327 6313

MEMBER OF THE AMATEUR RADIO RETAILERS ASSOCIATION



To add to the problem of VAT, prices of all equipment originating in Japan including SOMMERKAMP gear will now be increased by approximately 10% due to the revaluation of the yen which will eventually of course adversely affect second hand items. Thanks to the pre-VAT rush our stocks of used equipment are much lower than normal but at the time of going to press we still have several excellent items as shown below and if this appears in print before 1st April the opportunity still exists to buy without the imposition of VAT.

Collins KWM-2 Transceiver complete with Collins PSU. Little used and mint condition.

Collins KWM-2 Transceiver. gain with Collins PSU. Excellent.

Collins 75A-4 Receiver. Fitted 3 filters plus 1 spare. This is, without doubt, one of the finest 75A4's to pass through our hands and is in truly immaculate condition **£225.00**

Collins KWS-1 Transmitter. A rare transmitter indeed. Of matching appearance to the 75A-4 and with a kilowatt capability due to 4CX250's in the final. Less power supplies **£200.00**

Eddystone EA12 Receiver. In excellent condition **£145.00**

Eddystone EA12 Receiver. Absolutely immaculate, complete with speaker/plinth **£150.00**

KW2000 Transmitter. Good clean condition **£117.50**

Trio JR-310 Receiver. As new in all respects **£66.50**

Trio JR-310 Receiver. Very good condition **£61.00**

Trio JR-500 Receivers. Several in stock from **£45.00**

Lafayette HA-350 Receiver. Good condition **£61.50**

Heath HW-101 Transceiver. Less PSU. Most excellent condition **£81.50**

Heath HW-100 Transceiver. With both AC and DC PSU's... **£135.00**

ALL ITEMS ARE PRICED TO INCLUDE CARRIAGE

PLEASE NOTE : Our used equipment stocks are continually changing. An S.A.E. will bring you the latest list.
Home demonstration service on new gear available from our agents
SOUTHERN: J.H. Associates Ltd. (Jeff Harris G3LWM), Cricketfield Lane, Bishops Stortford, Herts. Tel. 0279-56347.
NORTHERN: J. Rowley, G3KAE, Castle Rise, West Ayton, Scarborough, Yorks. Tel. West Ayton 3039.

ELECTRON HOUSE, 508-514 ALUM ROCK ROAD, BIRMINGHAM 8.

Osker Block SWR200 Power Meters. The ultimate in SWR/Power Bridges ... **£19.25**

TCC SWR Bridges—
C3042 Single meter model **£5.00**

TCC SWR Power Bridges—C3005 Twin meter model **£7.85**

Sansei Miniature SWR/ Power Meter SE406... **£3.80**

Medco Filters. The best on the market.
F504 and FL75A, 50 ohm Belling connectors ... **£6.00**

FL50B and FL75B 75 ohm PL 259 connectors ... **£6.50**

FH40 High Pass... **£2.35**

Copal Clocks
All types ex-stock. Illustrated list by return.
Amphenol PL259 connectors ... ea. **30p**

Belling coaxial connectors ... ea. **10p**

50 ohm Heavy Duty coax (carriage extra) yd. **22p**

J Beam Antennas
Illustrated catalogue on receipt of S.A.E. Full range in stock.

G-Whip Antennas
All ex-stock, catalogue by return.

Shure Microphones
Model 201 Hand ... **£5.75**
Model 444 Desk ... **£13.25**

Mosley Antennas
TA31 Jnr. ... **£15.50**
TA32 Jnr. E ... **£25.00**
TA33 Jnr. E ... **£35.50**

Hy-Gain Antennas
12-AVQ vertical ... **£16.50**
14-AVQ vertical ... **£24.50**
18-AVT/WB vertical ... **£35.50**
LC-80Q Loading coil ... **£7.50**
TH3 Jnr. 3 ele beam ... **£51.50**
TH3 Mk. III 3 ele beam... **£75.00**
TH6 DXK 6 ele beam ... **£97.00**
BN-86 Balun ... **£8.00**
(Carriage extra on Mosley/Hy-Gain)

Rotators—all post paid
Stolle Memomatic 3001... **£22.40**
Stolle Automatic 2010 ... **£25.00**

CDE AR20 ... **£20.40**
CDE AR22 ... **£25.65**
CDE TR44 ... **£45.75**
CDE Ham-M ... **£70.80**

Wightraps
Standard pairs ... **£2.90**
High Power ... **£3.90**

SOLID STATE MODULES

Telephone: 0484 - 23997

**63 WOODHEAD ROAD,
SOLID, LOCKWOOD,
HUDDERSFIELD, HD4 6ER**

MEMBER OF THE AMATEUR RADIO RETAILERS ASSOCIATION

We would like to clarify a few points which have come to light of late. Firstly, we are not in a "part time" business or an off-shoot of any other business. We are fully employed manufacturing and supplying the radio amateur. We do have a number of professional and Government outlets but only for our amateur market equipment—modified for frequency coverage usually. This means that we are freely available to answer questions and provide a first class service to our customers.

Secondly, all the equipment advertised unless we specifically say so (e.g. second-hand equipment) is designed and made here in Huddersfield. Finally, in order to provide the service and standard of equipment design and alignment, we have had over the last five years to invest in a considerable amount of professional quality test equipment. The final results can only be as good as the standards used. To this end we have purchased a brand new current production, 3000 MHz spectrum analyser. This sweeps from 1000 MHz max. bandwidth for observing the complete spurious output content of our equipment, down to a 10 kHz minimum sweep for checking the intermodulation level of the desired signal. This was necessary to aid in the development of the Europa transverter. It will be also used to check intermodulation and spurious content of every Europa coming off the final test bench.

PLEASE NOTE THAT ALL PRICES QUOTED THIS MONTH ARE VAT INCLUSIVE

NEW ! SSM EUROPA 10 TO 2 METRE SSB TRANSVERTER
This unit plugs straight into Yaesu SSB equipment. Although it is compatible with all 28-30 MHz transceivers or separate transmitter/receiver arrangements. Receiver converter specification is the same as our Sentinels. Transmit converter uses two QVQ03/10 and a QVQ06/40 P.A. Overall size: 9" x 4 1/2" front panel 4" deep. Price: **£64.35** less valves. QVQ03/10, **£1.37**; QVQ06/40, **£11.00**.
3CG CRYSTAL CONTROLLED CALIBRATION GENERATOR, £17.60.

SPECIFICATION COVERING ALL OUR VHF CONVERTERS

- ★ Noise figure 2 dB. Gain 30 dB.
- ★ Protected dual gate MOSFETs in RF and mixers for excellent overload and cross modulation characteristics.
- ★ All housed in aluminium cases, stove enamelled silver hammer with black trim.

THE SENTINEL 2 METRE OR 4 METRE DUAL GATE MOSFET CONVERTER

By far the most popular converters. Stock IFs for 2 metres: 2-4 MHz, 4-6 MHz, 9-11 MHz, 14-16 MHz, 18-20 MHz, 23-25 MHz, 24-26 MHz, 27-29.7 MHz, 28-30 MHz; 4 metre IFs: 28-27 MHz. Size: 2 1/2" x 3" x 1 1/2" except the 2-4 MHz and 4-6 MHz which being double conversion are 2 1/2" x 4" x 1 1/2". Price: **£15.12**.

Now becoming very popular :

THE SENTINEL X DUAL GATE MOSFET 2 METRE CONVERTER

This 2 metre converter is a de luxe version of our well established Sentinel converter. Contains internal mains power supplier but can be used with external batteries. It features an RF gain control to reduce cross modulation and overload of the main receiver and may be switched between mains and battery. Size: 5" x 1 1/2" front panel 4" deep. It uses fundamental crystals on the required frequency, i.e. no multiplication. IFs from stock: 4-6 MHz, 2-4 MHz, 27-29.7 MHz, 28-30 MHz. Price including P.S.U. **£21.45**.

THE SENTINEL M.F.

Receives 2 metres on a conventional M.W. B.C. receiver, particularly useful for use with a car radio. IF output 0.5 to 1.5 MHz for 144-145 and 145-146 MHz in two switched bands. "OFF" position switches M.W. aerial straight through to receiver. Double conversion design with two switched crystal oscillators. No frequency multiplication. Size: 5" x 1 1/2" front panel 4" deep. Price: **£20.62**.

Want to improve your present 2 metre receive system ?

THE SENTINEL LOW NOISE FET 2 METRE PRE-AMPLIFIER

- ★ Low noise figure 1 dB. Transistors selected for low noise figure.
- ★ Gain 18 dB. 12v. D.C. at 5 mA. Isolated supply lines.
- ★ Very good for bringing converted business gear up to scratch. Also helps IF breakthrough by increasing the wanted 2 metre signals and gives greater selectivity. Price: **£7.15**.

Want to receive 70 cms, cheaply but well ?

SM70 70 cms. CONVERTER

- ★ Low noise figure 4-5 dB.
- ★ IF output 144-146 MHz. By using the 70 cm. converter with a 2 metre converter you can have a high performance 70 cm. unit at a low price, **£15.12**.

T.B.C. 1. Top band to Medium Wave converters. Price: **£8.25**.

SOLID STATE 9 MHz GENERATOR—£12.10 less filter and crystals, **£17.50** with XF-9A filter and USB and LSB crystals.

MAGNETIC DEVICES 951. 12v. coax change over relay, **£4.12**.

The mobile rally season has arrived. We will be attending most of the Midlands and Northern events. We supply over a dozen amateur retail outlets around the country who should be able to supply equipment from the other rallies.

Although we cannot give an ex-stock delivery of the SSM Europa at the moment, we believe that all other units should be ex-stock, but you can always ring for confirmation. Call in any time to have a look at the stuff. G3MXG.

NORTH WEST ELECTRICS, G3MAX

769, STOCKPORT ROAD, LEVENSHULME,
MANCHESTER, 19.

Phone: 061-224 4911

EDDYSTONE RECEIVERS & DIECAST BOXES. TRIO RECEIVERS. JACKSON CAPACITORS & DRIVES. DENCO COILS.

TRANSFORMER. Specially wound for Digital instruments. 200 volt 40 mA HT. 6 volt 1A. Two windings LT. Will supply 6v. 2A. or 12v. 1A. CT $2\frac{1}{2}'' \times 2'' \times 2\frac{1}{4}''$, £1.50, post 25p.

TRANSFORMER for clock, £1.25, post 25p.

TRANSFORMER. Ex. Equip. potted. 4 x 6.4v. at 2A. each winding tapped at 5v. and 2.5v. size $4\frac{1}{2}'' \times 3'' \times 3''$, £1.75, post 50p.

INSTRUMENT CONTROL KNOBS. Black and bright Ali. centre, $\frac{1}{4}''$ brass insert with grub screw. 1", $1\frac{1}{4}''$ and $1\frac{1}{2}''$ dia., 15p each, post 5p each. Any excess refunded.

DIECAST BOXES. With fitted lid. Post 10p per box.

Cat. No. 7969P $3\frac{1}{2}'' \times 1\frac{1}{2}'' \times 1\frac{7}{32}''$,	39p
Cat. No. 7134P $4\frac{1}{2}'' \times 2\frac{1}{2}'' \times 1''$,	46p
Cat. No. 6908P $4\frac{1}{2}'' \times 3\frac{1}{2}'' \times 2''$,	65p
Cat. No. 6827P $7\frac{1}{2}'' \times 4\frac{1}{2}'' \times 2''$,	£1.04
Cat. No. 6357P $7\frac{1}{2}'' \times 4\frac{1}{2}'' \times 3''$,	£1.13

Sizes shown are approx. internal dia.

ALI. MINI BOXES. With fitted lid. Post 5p per box.

$3'' \times 2'' \times 1''$, 33p	$5\frac{1}{2}'' \times 4'' \times 1\frac{1}{2}''$, 43p
$4'' \times 2\frac{1}{2}'' \times 1\frac{1}{2}''$, 38p	$4\frac{1}{2}'' \times 2\frac{1}{2}'' \times 2\frac{1}{2}''$, 38p
$4'' \times 4'' \times 1\frac{1}{2}''$, 38p	$5'' \times 2\frac{1}{2}'' \times 1\frac{1}{2}''$, 38p

FINNED ALUMINIUM HEAT SINKS. $5'' \times 2''$ ready drilled for TO3, 25p. $5'' \times 4''$ undrilled, 37p. $5'' \times 8''$, undrilled, 65p, post 10p.

POLYPROPYLENE ROPE. 500 lb. Strain. 100 yd. reel, £1, post 15p. (This item is now in stock).

CONSTANT VOLTAGE TRANSFORMER. Brand new. Advance. 60 watts 230v., £7, carr. £1.

DENCO COILS. Most ranges in stock, 40p ea., post paid.

CONTROL UNIT, TYPE 384. This unit contains : $3\frac{1}{2}''$ desyn indicator. 5 mA right hand zero meter $1\frac{1}{2}''$ dia. 6 var. res. with gear drive on 2.2 DP push buttons. 2-1 pole 12 way. 1-8 pole 5 way, 2 bank switches. 3-62, 2-42 ohm 5W res. Excellent value, 87p, post 27p.

IF STRIP. Ex R3673 Rx. 7.5 MHz with circuit. Less valves. 8 B7G PTFE holders. Sealed relay twin 500 ohm coil. 12 pin plug and socket, 50p, post 20p.

CONVERTER 20 to 90 MHz. 7.5 MHz IF. Ex 3673 Rx. 2/EF91's. 1-616 Osc., £1.25, post 20p. Some less valves, 75p, post 20p. Supplied with circuit.

Business Hours : Tuesday-Friday, 9.30 a.m. to 6.00 p.m.

SATURDAY : 9 a.m.-5 p.m. OPEN ALL DAY

CLOSED ALL DAY MONDAY

COMPONENTS

FOR

FREQUENCY COUNTERS & CLOCKS

8 DIGIT READOUT BOARD ASSEMBLY, £4.50, post 10p. Printed to use ZM1020 1" dia. end readout tubes. Front board takes holders for ZM1020s and 74141N Nixie drivers. Back board takes 7490 and 7475 Quad latch. Boards mount back to back to make an ideal assembly for frequency counter, etc. Board size : $10'' \times 2\frac{1}{2}''$. Front or back board available, £2.25 ea.

READOUT BOARD. 4 Digit, uses GNP7 wire ended, side viewing tubes. 7490 dividers, 7475 latch and 74141N Nixie driver. Printed for reset 0, can be wired to reset 9. Size : $4\frac{1}{2}'' \times 3''$. £1.50, post 5p.

GNP7. Wire ended side viewing. A7001 Wire-ended side viewing, £1.50 ea. Post Paid.

TIME BASE BOARD. Gives all pulses needed to control readout for counter. Uses 7400 Osc. 1 MHz. 6 off 7490 Divider chain to 1 cycle. 7474 clocked dual D, 7413 Schmitt trigger. 7400 pulse outputs. 2N3708 latch output. Size : $4\frac{3}{8}'' \times 2\frac{1}{2}''$. Use BC107 to drive 8 latches, £1.50, post 5p.

PRINTED BOARD FOR 72710N op amp. Counter front end. $2\frac{1}{2}'' \times 1\frac{1}{4}''$, 45p, post paid.

PRINTED CIRCUIT HOLDERS FOR ZM1020, 28p each, post 5p. 8 way ribbon cable for connecting boards, 20p yd., post 5p. yd. (8 x 4" sections required for linking boards.)

READOUT TUBES. ZM1020 1" dia. end viewing, £1.50 each with holder, 4 for £5, post paid. Supplied with Chassis or printed circuit holders.

DIGITAL CLOCK BOARD. 4 digit 12 hour. Uses 7 off SN7490's. 1-SN7413, 3-SN74141, 1-C407. Printed to use A7001 midget side viewing tubes, £1.50, post 5p. $4\frac{1}{2}''$ square.

A7001 TUBES. Full set of parts for 12 hour clock, £20, post paid.

NEW TEXAS I.C.'s. 7400, 22p; 7413, 40p; 7490, 86p; 7474, 45p; 74141, £1.12; 7475, 55p; 72710, 46p; 72741, 75p. Post 5p each.

ALL BOARDS ARE HIGH QUALITY PRINT ON FIBRE GLASS. HOLDERS FOR I.C.'s. Low profile 14 or 16 pin, 15p each, postage 5p each and including up to 5 off.

WE WELCOME ALL ENQUIRIES HOWEVER SMALL
Stamped address envelope please for special offer list.

MEMBER OF THE AMATEUR RADIO RETAILERS ASSOCIATION

YOUR MIDLAND STOCKISTS

Stabilised P.S.U. 240v. A.C. input, 3-6-7.5-9v. D.C. output 4A., £3.75, 16p Carr.
Packs of connecting wire, 5 x 5 yds., flexible or solid, 20p, 10p Carr.
Packs of resistors, assorted values, 75p, 16p Carr.
Packs of capacitors, assorted values, 75p, 16p Carr.
Recording tape by well known manufacturer, (not boxed), 5in. STD, 38p, 16p Carr.; 5in. LP and 5½in. STD, 45p, 16p Carr.; 5½in. LP and 7in. STD, 60p, 16p Carr.; 7in. LP, 80p, 16p Carr.
CI134 valves (equiv. to QQVO 3-20A.), £5.00, 16p Carr.
Ferric chloride liquid, 500 ML, 52p, 16p Carr.
Super servisol switch cleaner aerosol, 40p, 16p Carr.
Invertor transformer with circuit, 12v. D.C. to 230v. A.C. 40w. approx. 50 Hz, £3.25 16p Carr.
Cassette tapes by Scotch, Philips, EMI, BASF, Agfa, C60, 52p, 8p Carr.; C90, 74p, 8p Carr.; CI20, £1.09, 8p Carr.
Finiguns Hammerite paint, 250 ML, 40p, 16p Carr.; 500 ML, 80p, 16p Carr.; ½ gal., £2.45, Carr. at cost; 1 gal., £3.00, carr. at cost. Colours: black, silver, red, deep green, deep blue, blue, bronze, green.
WE STOCK A COMPREHENSIVE RANGE OF R.S. COMPONENTS, J. BEAM AERIALS AND FITTINGS

YAESU MUSEN
FT101 Transceiver 160-10M. £255.00
FR50B receiver, 80-10M with cal. £63.00
FT2FB 2M transceiver with tone burst £89.00

PRICES SUBJECT TO CURRENCY REVALUATION

TRIO
9R-59 DS receiver 5-30 MHz £49.50
JR310 receiver, 80-10M £75.00
SP5D speaker £4.50

PRICES SUBJECT TO CURRENCY REVALUATION

KW
2000E transceiver, 160-10M £265.00 with A.C. P.S.U.
202 receiver, 160-10M £140.00 speaker for above £8.00
204 transmitter, 160-10M £160.00

EDDYSTONE
CI10 Mk. II receiver, 5-30 MHz £86.00

TEST METERS

			Carr.
TMK	TP10S	2K/V	£6.77, 21p
	TP55	20K/V	£8.91, 21p
	500	30K/V	£13.00, 21p
	700B	50K/V	£29.96, 25p
Sanwa	P2B	2K/V	£5.77, 21p
	JPSD	2K/V	£6.93, 21p
	U50DX	20K/V	£9.90, 21p
	A303TRD	20K/V	£13.00, 21p
AVO	380CE	33-3K/V	£18.90, 21p
	Mk. IV	20K/V	£45.00, 25p
	Brzennose	200H	20K/V

TEST EQUIPMENT

Osker power meter	SWR 200 52/75 Ω	£18.50, 25p
Tech TE-15 GDO	44 280 MHz	£13.50, 25p
KW 107 ATU/SWR meter		£46.00, 29p
KW 101 SWR meter		£8.25, 25p
KW 103 SWR/power meter		£12.50, 25p
Raymart Bandchecker		£5.25, 25p

AERIALS

Bantey fibreglass 2M ½ wave	£4.35	Carriage
Halsol 160M whip	£7.40	at cost
G whip 160M Ranger	£7.50	approx.
G whip 160/80M	£9.00	£1.00

PLEASE ADD 10% VAT TO ALL PRICES



170-172 CORPORATION ST. BIRMINGHAM B4 6UD

NO C.O.D. PLEASE PRINT YOUR ADDRESS. YOU MAY ORDER GOODS BY PHONE AND PAY BY ACCESS OR BARCLAYCARD. SIMPLY QUOTE YOUR CARD NO. TEL: 021-236-1635



TERMS Retail mail order subject to £1.00 minimum order.
 Cash with order only. Trade and educational establishments M/AC on application (minimum £5.00).
 Postage 10p inland. 25p. Europe
 GUARANTEE: All goods carry full manufacturer's warranty. Get in touch today for a complete run-down of devices available from SCS (include SAE).



SCS COMPONENTS, P.O. Box 26, Wembley, Middlesex HA0 1YY
 The 'Professional' Amateur Supplier

device of the month ZN414

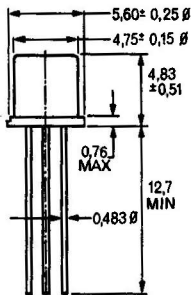

The Ferranti ZN414 is a complete a.m. radio circuit which operates from 1.1 to 1.8 volts and requires only battery, earphones and antenna plus a tuning capacitor and two decoupling capacitors. The ZN414 features: medium and long waveband, good stability on assembly, no setting up of IF coils, plus much more.

a complete a.m radio circuit for just **£1.20**

compatible device MFC4000

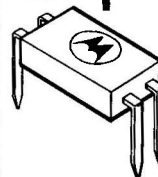

The Motorola ¼-Watt Audio Amplifier is designed for the output stage of battery powered portable radios.

- * 250 mW of Audio Output Power
- * Low Standby Current— 3-5 mA typical
- * Low Harmonic Distortion
- * Reduces Component Count in Portable Radios by Two Transformers and Two Transistors
- * Eliminates Costly Component Matching Requirements

motorola ¼ watt audio amplifier **50p**
MFC4000

TELFORD COMMUNICATIONS

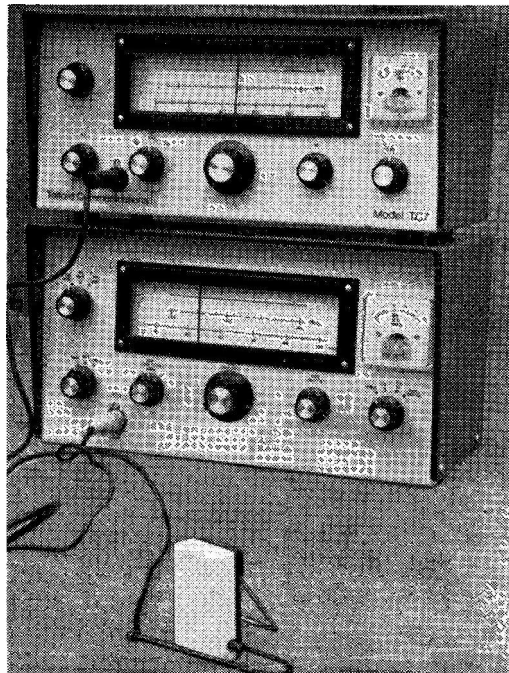

TC7 Tunable I.F.
AM/FM/CW/SSB. Flywheel drive. Any 2 MHz coverage to order in the range 20 to 30 MHz. Mains or 12 volt negative earth operation. Spare capacity on mains operation to power converters or QRP Tx's etc. 'S' Meter. Noise Limiter. Dual gate mosfets in R.F. and Mixer. 1.6 MHz 2nd. I.F. Built in monitor loudspeaker. Ext. L.S./Phones jack on front panel. Case size 12" x 5½" x 6½". Visor front, finished in attractive dark grey hammer stove enamel, with cream front panel, black dial escutcheon and knobs. Weight 5½lbs. PLEASE STATE CLEARLY YOUR REQUIRED I.F. WHEN ORDERING.
Price: Including 'Securicor' delivery £43.00.
By personal collection from our works, £40.00.

TC9 2 Metre Transmitter
AM on crystal control, AM or FM on VFO control. One crystal at specified frequency included. All solid state. 10 Watts RF output. Fully metered. Mains operated, stabilised PSU. Aerial changeover and control/muting relays, AM/FM, modulator, Flywheel driven VFO, all included. Case size 12" x 7" x 6½", with visor front and finish to match TC7. Weight 1½ lbs. Press to talk microphone supplied. D.C. operation feasible. PLEASE STATE CLEARLY YOUR REQUIRED XTAL FREQUENCY WHEN ORDERING.
Price. Including 'Securicor' delivery £73.00.
By personal collection from our works £70.00.

G8AEV 2 Metre Converter
Cascode neutralised R.F. stage using fets. Dual gate mixer. Circuitry and performance equivalent to similar types costing 50% more. Any I.F. to order in the range 2 to 30 MHz. Three I.F. outputs via emitter followers for contest use etc. to feed up to three Tunable I.F.'s. Typical conversion gain 20 dB. Typical noise figure 2.8 dB. 9 to 15 volt D.C. operation, isolated earth. Supplied in plain aluminium box, 4½" x 2½" x 1½" with Belling Lee R.F. and I.F. sockets, and power sockets. Crystal included. PLEASE STATE CLEARLY YOUR REQUIRED I.F. WHEN ORDERING.
Price £12.00.

TC7 Bandsearcher Module
Electronic tuning unit for use with our TC7 Tunable I.F. Enables the whole 2 MHz band to be automatically searched for calling stations once every minute. Supplied in plain aluminium box, with flying leads for connection to TC7 ancillary socket. Switch provided for selection of manual or automatic tuning.
Price £4.00.

2 Metre Aerial Filter
Insertion loss not greater than 1 dB. Attenuation at plus and minus 12 MHz, typically 25 dB. Power handling capability 10 watts. Ideal for use with TC9 Tx. 75 ohm matching impedance. Belling Lee input and output sockets. Supplied in diecast box, 4½ x 2½ x 1½.
Price £5.00.

Further details of all units and current delivery positions on request. (S.A.E. please.) Terms C.W.O or 10% deposit with balance Pro-forma invoice. H.P. terms available.

VAT at Standard rate will be added to all prices from April 1st.

TELFORD COMMUNICATIONS
78B HIGH STREET, BRIDGNORTH,
WV16 4DS, SALOP.
Tel. 074 62 4082.

(G8ARS)

(Photo by G8BJ)

CALL BOOKS

INTERNATIONAL :

RADIO AMATEUR CALL BOOKS (1973)	
"DX Listings"	£2.95
"U.S. Listings"	£3.75
"G's" only 1973	70p

MAPS

AMATEUR RADIO MAP OF WORLD

Mercator Projection — Much DX Information — in colour. Second Edition 65p

DX ZONE MAP (GREAT CIRCLE)

In colour with Country/Prefix Supplement Revised to January 1972 85p

RADIO AMATEUR MAP OF THE U.S.A. AND NORTH AMERICA

State boundaries and prefixes, size 24" by 30", paper 60p

RADIO AMATEUR'S WORLD ATLAS

In booklet form, Mercator projection, for desk use. Gives Zones and Prefixes (New Edition). £1.10

LOG BOOKS

Standard Log (New Glossy Cover)	55p
Receiving Station Log	45p

(The above prices include postage and packing).

MORSE COURSES

G3HSC Rhythm Method of Morse Tuition

*Complete Course with three 3 speed L.P. records with books	£4.50
*Beginner's Course with two 3 speed L.P. records with book .	£3.30
Single 12" L.P. Beginner's with book	£2.75
Single, 12" L.P. Advanced with book	£2.75
Three speed simulated GPO test. 7" d.s.E.P. record	85p

Prices include postage, packing and insurance in U.K. only *Overseas orders + £1.00.

Available from

SHORT WAVE MAGAZINE

Publications Dept., 55 Victoria Street,
London, SW1H 0HF 01-222 5341

(Counter Service, 9.30-5.15, Mon. to Fri.)
(Nearest Station: St. James's Park)

(GIRO A/C No. 547 6151)

NEW — HEATHKIT 2-METRE TRANSCEIVER HW-202



OPTIONAL EXTRAS :
Tone Burst Encoder
Regulated A.C. Power Supplies

Coming in May

Features -

All solid-state design
Can be completely aligned without instruments

Multi-channel capability—
independent pushbutton selection of 6 transmit and 6 receive crystals

10-Watts Minimum Output—
designed to operate into even an infinite VSWR without failure

Optional Tone Burst Encoder—
mounts inside, gives front-panel selection of four presettable tones

Available with a full-line of accessories—
for both mobile and fixed operation

Includes push-to-talk mike—
ceramic tailored-response microphone provides outstanding audio transmission

We think you'll agree it's worth waiting for. The Heathkit HW-202 compares with the best wired amateur 2M/FM rigs you can buy. Plus it has multi-channel capability via independent selection of 6 transmit and 6 receive crystals. Solid-state circuitry with complete built-in alignment procedures using only the manual and the front-panel meter allow operation over a 1 MHz segment from 143.9 to 148.3 MHz. Removable front-panel bezel permits installation of the new Heathkit HWA-202-2 Tone Burst Encoder. Operational stability over a wide —30° to + 50° C range.

10-15 watts transmission into an infinite VSWR—indefinitely, with no failure! The HW-202 needs no automatic shut-down—it continues to generate a signal regardless of antenna condition. Transmitter deviation is fully adjustable from 0 to 7.5 kHz, with instantaneous deviation limiting. Harmonic output is greater than —45 dB from carrier.

The Heathkit HW-202 comes with two crystals that are used in initial set-up and alignment, and give you simplex operation, quick-connecting cable for 12-volt hook-up, heavy duty alligator clips for use with a temporary battery, antenna coax jack, gimbal bracket, and a unique mobile mount that lets you remove the radio from the car by simply unscrewing two thumbscrews.

The repeaters are waiting—there are probably several open repeaters in your area now. So here's an economical Heathkit rig to get you in on the activity—with all the mobile portability, fixed-station versatility and all-round high performance you want.

Kit K/HW-202 9 lbs. £89.10 + 66p P & P
(inc. £8.16 V.A.T.)

HW-202 SPECIFICATIONS—RECEIVER—Sensitivity : 12 dB SINAD* (or 15 dB of quieting) at 5µv or less. Squelch threshold : 3 µv or less. Audio output : 2 W at less than 10% total harmonic distortion (THD). Operating frequency stability : Better than ±.0015%. Image rejection : Greater than 55 dB. Spurious rejection : Greater than 60 dB. IF rejection : Greater than 75 dB. First IF frequency : 10.7 MHz ±2 kHz. Second IF frequency : 455 kHz (adjustable). Receiver bandwidth : 22 kHz nominal. De-emphasis : —6 dB per octave from 300 to 3000 Hz nominal. Modulation acceptance : 7.5 kHz minimum. **TRANSMITTER—**Power output : 10 watts minimum. Spurious output : Below —45 dB from carrier. Stability : Better than ±.0015%. Oscillator frequency : 6 MHz, approximately. Multiplier factor : X 24. Modulation : Phase, adjustable 0–7.5 kHz, with instantaneous limiting. Duty cycle : 100% with ∞ VSWR. High VSWR shutdown : None. **GENERAL—**Speaker impedance : 4 ohms. Operating frequency range : 143.9 to 148.3 MHz. Current consumption : Receiver (squelched) : Less than 200 mA. Transmitter : Less than 2.2 amperes. Operating temperature range : —10° to 122° F (–300 to +50° C.). Operating voltage range : 12.6 to 16.0v. DC (13.8v. DC nominal). Dimensions : 2½" h x 8½" w x 9½" d.

$$*SINAD = \frac{\text{Signal} + \text{noise} + \text{distortion}}{\text{Noise} + \text{distortion}}$$

Free Catalogue

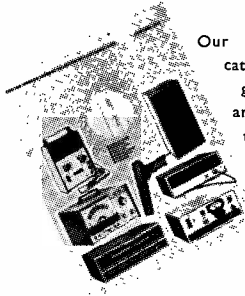

Our jumbo sized Heathkit catalogue is full of good things. Stereo amplifiers, tuner amplifiers, tuners, loudspeakers and audio accessories, electronic calculator, metal detectors, shortwave receivers, intercoms . . . even a powerful battery charger kit.

(Mail order prices and specifications subject to change without notice)

Please send me a FREE Heathkit catalogue

Name _____

Address _____

HEATH

Schlumberger

Heath (Gloucester) Limited, Dept. SW4/73
Gloucester GL2 6EE. Telephone 0452 29451

HEATH (GLOUCESTER) LTD.,
GLOUCESTER GL2 6EE

... another
winner from

KW

The KW 2000E

A KW 2000E with 500 kHz
VFO COVERAGE 10-160
metres

Complete with
AC PSU **£265.00**
+ VAT (carriage extra)

Includes the following features :

TOP BAND with switch to legal U.K.
limit.
Reliable 6146's in PA.
Built in Calibrator 100 Hz + WWV.
IRT/ITT & VOX.
"Break in" CW. All crystals supplied.
10 metres coverage 28.0-30.0 MHz.
KW after sales service and spares for 5
years (possible 10 years).
New R.F. Stage.
Smooth 2 speed Slow-motion drive.

K. W. ELECTRONICS LTD.

1 Heath Street, Dartford, Kent.
Tel. Dartford 25574/21919



ALSO—KW 202 Receiver 10-160m. KW204 SSB/CW/AM
Transmitter. KW 107 SUPERMatch. KW 103 SWR/RF
Power Meter. KW 101 SWR Meter (52 and 75 ohm).
KW E-Z Match. Low Pass Filters.

Antennas—Beams—Dummy Load—Antenna Switch—Baluns,
etc.

NOW AVAILABLE—KW MONITORSCOPE in matching
'G' Line Cabinet—KW 2000B/202/204/107/ etc.

Write or 'phone for latest catalogue.

KW
ELECTRONICS
LIMITED

All Equipment Available
through accredited agents

EASY TERMS ON EQUIPMENT AVAILABLE OVER 12, 18 OR 24 MONTHS

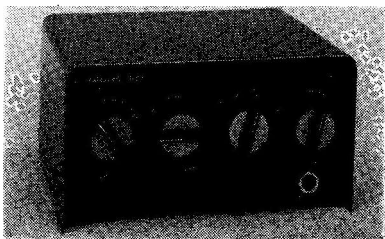

P.M.IIA

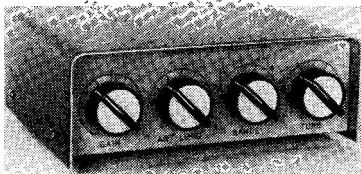

P.M.IIB

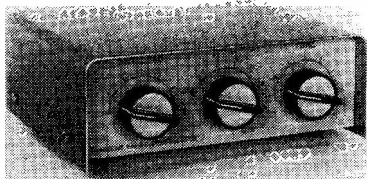

P.M.IIC

HAMGEAR PRESELECTORS

P.M.IIA. This covers from 1.8 to 32 MHz in six overlapping ranges, having an antenna tuner to make the most of your antenna, followed by an EF80 to amplify the signal to some 20/25 db before it reaches the receiver. Complete with its own silicon/transformer power pack with fuse and indicator. **£9.20** plus 29p postage.

P.M.IIB. All solid state covering the same ranges as the P.M.IIA 1.8/32 MHz with an antenna tuner. Utilizing an F.E.T. with Bipolar. Having a gain of some 20/25 db. Controls as the P.M.IIA having "Antenna Load," Bandswitch, "Tune" and Gain control. Battery powered. **£8.50** plus 25p postage.

P.M.IIBX. Specification as the P.M.IIB with the addition of an internal mains power supply with indicator and fuse. **£10.80** plus 25p postage.

P.M.IIC. Our latest and lowest priced solid state unit covering 3.5 MHz to 32 MHz in five overlapping ranges with an antenna tuner. Having the same R.F. section, F.E.T. with Bipolar and gain as the P.M.IIB. This unit features a "Listen Thru" facility; when it is switched off the antenna automatically bypasses the unit and goes direct to the receiver. Having three easy to use controls, Antenna Load, Tune and Bandswitch. Battery powered and priced **£6.85** plus 25p postage.

All these units have silver hammer cases, engraved front panels and black and silver knobs. Send for illustrated leaflets on this equipment and our range of calibrators.

HAMGEAR ELECTRONICS
29 CARLYLE ROAD, NORWICH, NOR 66C

ADVERTISERS INDEX

	Page
Amateur Electronics (G3FIK)	73
B.I.E.T.	71
The Amateur Radio Shop (Huddersfield)	125
J. Birkett	125
British National Radio School	125
I. N. Cline	122
Derwent Radio	121
E. & E. Services	124
Eddystone Agents	124
Ensign Electronics	123
G3HSC	115
G.W.M. Radio	123
Hamgear Electronics	78
Heath (Gloucester) Ltd. . . .	77
Holdings Photo Audio Centre (Trio)	124
Imhofs	123
Johns Radio	117
K. W. Electronics	124
K. W. Developments, Ltd.	70
Lowe Electronics	66, 67
S. May (Leicester) Ltd.	70
Mosley Electronics	72
Gerald Myers	71
North West Electrics	74
P. & P. Developments	<i>back cover</i>
Partridge Electronics Ltd.	78
Radio Shack Ltd <i>inside front cover</i> ,	65
The Radio Shop (Bristol)	119
R. T. & I. Electronics Ltd.	72
Scientific & Tech.	120
R. Sellers	121
SCS Components	75
Senator Crystals	70
Semicon Indexes	115
Shure Electronics <i>inside back cover</i>	
Small Advertisements	115-120
Solid State Modules	73
Spacemark	125
SSB Products	122
Stephens-James	71
Strumech Engineering	123
Studio Electronics	116
S.W.M. Publications <i>back cover</i> ,	71, 116, 121, 122, 126, 127, 128
Taurus Electrical Services	124
Telecommunication Services	120
Telford Communications	76
Reg Ward & Co. Ltd.	121
Waters Electronics	116
Western Electronics Ltd.	68, 69
Chas. H. Young Ltd.	75

SHORT WAVE MAGAZINE

(GB3SWM)

Vol. XXXI

APRIL, 1973

No. 354

CONTENTS

	Page
Editorial— <i>Mobile</i>	81
Communication and DX News, <i>by E. P. Essery, G3KFE</i>	82
Sideband Transverter for Two Metres, Part II, <i>by J. D. V. Ludlow, GW3ZTH, & C. J. Dunbar GW8EHK</i>	87
Co-Adaptor Belling/BNC	92
Front-End Tuning, <i>by R. A. Penfold</i>	93
Inexpensive Dummy Load, <i>by G. Denby, G3FCW</i>	95
F/S Meter for 23 Centimetres	98
Specially on The Air	99
Looking at The K. W. Atlanta, <i>by F. G. Rayer, A.I.E.R.E., G3OGR</i>	100
Crystal Microphone Amplifier, <i>by A. Langton</i>	102
VHF Bands, <i>by A. H. Dormer, G8DAH</i>	103
The Mobile Scene— <i>Rally Fixtures</i>	108
The Month with The Clubs— <i>From Reports</i>	109
New QTH's	110

Managing Editor: AUSTIN FORSYTH, O.B.E. (G6FO/G3SWM)

Advertising: Maria Greenwood

Published at 55 Victoria Street, London, SW1H-0HF, on the last Friday of the month, dated the month following. Telephone: 01-222 5341 & 5342

Annual Subscription: Home: £2.75 (£3.00 first class) post paid
Overseas: £2.75 (\$7.00 U.S.), post free surface mail

Editorial Address: Short Wave Magazine, BUCKINGHAM, MK18 1RQ, England

AUTHORS' MSS

Articles submitted for Editorial consideration must be typed double-spaced with wide margins on one side only of quarto or foolscap sheets. Photographs should be lightly identified in pencil on the back with details on a separate sheet. All drawings and diagrams should also be shown separately, and tables of values prepared in accordance with our normal setting convention—see any issue. Payment is made for all material used, and it is a condition of acceptance that full copyright passes to the Short Wave Magazine, Ltd., on publication.

© Short Wave Magazine Ltd.

★ ★ ★ ★ ★ ★ ★ ★ ★ ★
SAVE ON PRE-VAT
 ★ ★ ★ ★ ★ ★ ★ ★ ★ ★
PRICES!!!
 ★ ★ ★ ★ ★ ★ ★ ★ ★ ★

PARTRIDGE PACKAGES SAVE YOU
 CASH ON PRE-VAT PRICES OF THE
 SAME ITEMS PURCHASED
 SEPARATELY!

The Space Age WORLD RECORD award winning 7' 6" long All Band JOYSTICK VFA Antenna—JOYMATCH A.T.U.—TRIO RECEIVER or TRANSCEIVER—Matching HEADPHONES—A COMPLETE STATION IN ONE COMPACT PACKAGE—THE FLAT DWELLER'S DREAM!

★ 1972 JOYSTICK VFA £12.54 (A); JOYMATCH ATU III or IIIA £12.54 (B); JOYMATCH ATU LO-Z500 £18.04 (C).

COMMUNICATIONS HEADPHONES £2.86 (D)

(All including carriage, packing, accessories and insurance)

PARTRIDGE PACKAGE No. 1
 9R59DS receiver ... £54.45
 *Items (A); (B); (D) above £12.10
 Complete Gen. Coverage
 Station ... £66.55

PARTRIDGE PACKAGE No. 2
 JR310 receiver... £82.50
 *Items (A); (B); (D) above £7.70
 Complete Amateur
 RX Station ... £90.20

PARTRIDGE PACKAGE No. 3
 JR599 receiver... £203.50
 *Items (A); (B); (D) above FREE
 Complete Amateur
 RX Station ... £203.50

PARTRIDGE PACKAGE No. 4
 TS/PSS15 Transceiver
 180W ... £231.00
 *Items (A); (C); (D) above FREE
 Complete TX-RX
 Station ... £231.00

**BARCLAYCARD — ACCESS — PERSONAL
 LOANS !!**

ALSO: SP5D SPKR. £4.95; OA2 MAINS STABILISER 74p

NEW: World-wide reception on the amazing "DX—CRYSTAL SET" £2.20 including unique aerial.

PARTRIDGE BUDGET LINE—

ARTIFICIAL EARTH—SOLVES YOUR EARTH PROBLEMS £5.28; AERIAL BANDSWITCH—TUNED AERIAL £5.28; A.T.U. KIT—FULL COVERAGE TX/RECEIVER £5.28; ASSEMBLED £6.38.

(All including carriage, packing, accessories and insurance)
 Send 3p stamp for full illustrated details of Partridge Products.

TRIO brochures (state which) 3p stamp extra.

**ALL PRICES INCLUDE V.A.T. AT 10%
 NO V.A.T. ON OVERSEAS ORDERS
 CARRIAGE AND INSURANCE EXTRA OVERSEAS**

BOX 4,

PARTRIDGE
 BROADSTAIRS KENT ENGLAND
ELECTRONIC LTD

Phone: 0843 62535 or 62839 cheap periods

A limited number of these titles specially imported from the States—please order your copy early. It may not be possible to repeat some of these.

ABC'S OF SHORT-WAVE LISTENING

Have you ever listened to a radio and thought how enjoyable it would be to hear broadcasts from faraway places, such as Toronto, Berlin, and Tokyo, as well as signals from ships at sea and satellites in space. All these broadcasts can be at your fingertips, offering a fascinating hobby.

ABC's of Short-Wave Listening a non-technical guide, will help you get started, or give you added pointers if you are now engaged in the hobby. The mysteries of radio waves are revealed in a manner that anyone can understand, providing priceless knowledge about the ever-expanding world of short-wave radio. £1.60

**BUILDING YOUR AMATEUR RADIO
 NOVICE STATION**

This book is the first "completely detailed" construction manual for building an amateur novice radio station. Nothing is overlooked in building the station from scratch to the actual on-the-air operation. The transmitter and receiver are distinctly professional in performance quality and appearance.

The book is primarily directed to the novice radio ham, it contains many novel and valuable construction hints and tips for amateurs in any licence class. As a finished touch to the projects a complete "rollaway" ham shack for hams with limited space (apartment dwellers, etc.) is featured and fully described.

By W7OE

£1.90

HAM ANTENNA CONSTRUCTION PROJECTS

Besides full details on many useful and interesting types of aeriars, Ham Antenna Construction Projects includes complete information on long-lasting construction methods, as well as how to position your antenna to achieve maximum distance with a given radiation pattern. In addition, much easy-to-understand technical information on tuning antennas and the use of test equipment is presented. £2.10

SWL ANTENNA CONSTRUCTIONAL PROJECTS

Two chapters cover the basic principles of antennae and the knowledge necessary for construction of the projects which are given in the following pages. The antenna projects themselves are divided into six classes. First are the dipole aeriars such as segmented and inverted types. Following them are the vertical antennae, including array and beam types. Then horizontal beam systems (Yagis) are considered. Various low- and high-band and multiband triangle antennae are also discussed. The next section deals with long-wire antennae, such as vee beams and rhombics, for those SWL'ers with a sizeable plot of land available. For SWL'ers without land, indoor antennae, which are included in the final section, may be a solution. Three useful appendices are provided at the end of the book. O/P

TRANSISTOR FUNDAMENTALS—Vol. III

Covers circuits used in radio, audio and television equipment. It also introduces you to logical troubleshooting procedures used in locating defective parts or faulty adjustments in these circuits. This book will help you learn to repair many transistor circuits used in audio amplifiers, radio and television receivers. £2.40

RADIO CIRCUITS

By Thomas M. Adams

This volume goes into great detail in explaining the action of the various circuits used in radio receivers—also voltage analysis and signal substitution methods for servicing typical valve and transistor receivers. £1.80

The above prices include postage and packing

Available from

SHORT WAVE MAGAZINE

Publication Dept.,

55 Victoria St., London SW1H 0HF

Telephone 01-222 5341

(Counter Service 9.30-5.15 Monday to Friday)

(Nearest Station: St. James's Park)

GIRO A/C. No. 547 6151)

The
SHORT-WAVE
Magazine

E D I T O R I A L

Mobile

Ever since the Post Office brought mobile operation within the orbit of Amateur Radio in this country, there has been a steady increase in the number of cars fitted for transmission and reception on our bands while actually on the move. There are now about 3,700 U.K. amateurs licensed mobile, covering between them all amateur bands.

There are many ways in which an installation can be designed for mobile working, and many different types of vehicle in which it can be fitted—from the smoothly-engineered job built into a high-priced sports saloon or smart estate car, to the bread-board lash-up accommodated on the back seat of a grunting old buggy. Whatever the vehicle, there are numerous practical problems to be solved: The band to use, type of receiver and transmitter, power supply, suppression, change-over, aerial arrangement and full control in safety under traffic conditions on the road—as well as whether the installation is to be built in as a permanent fixture, or made removable.

Amateur mobile operation is still mainly on our 160 and 2 metre bands (which in themselves pose quite different problems of major design) with a certain amount of /M activity on several of the HF channels.

Many of these stations are intended to be /PM, in the sense that they can be operated either strictly /M while actually on the move, or /P at a fixed site for field-day and similar activities, in the latter case with an aerial system beyond what can be carried on a moving car. Whatever the intention, it would seem that there should be a clear differentiation between /P and /M working, under such conditions. A station signing “mobile” should, surely, be on a public road with the wheels turning and, if temporarily stationary, should in any case be working into the mobile aerial system as normally carried on the car when on the move. Under all other conditions—using its fitted gear, but with the car parked and a specially erected aerial—the station should sign /P. Thus, it can be seen that by making the aerial system the deciding factor, a fair definition of “mobile operation” can be obtained.

* * * *

And in this context, remember the “Solo Mobile Tests” proposed for April 8, May 20, June 10 and July 8—see p.34, March issue for details. Do send in a report!

*Austin Forsyth
G6FO*

COMMUNICATION and DX NEWS

E. P. Essery, G3KFE

EX-R.A.F. types may have wondered, after the War, where all the gremlins which used to plague them went to; to which G3KFE can suggest that possibly the King of the Gremlins—or at least a Crown Prince—is at the moment of writing lurking in the inside of his previously-trusty transmitter. What is more, just as soon as any attempt is made to drag forth the oscilloscope or the test-meter he goes into hiding, from which he can only be dislodged by putting away the test-gear. One would not mind the incoming signal going down by a couple of S-points, nor even the outgoing one doing the same at inconvenient moments; but when all the spare energy thus released is turned to working local TV sets, the joke has gone too far. Has anyone a *reliable* anti-gremlin specific?

However, one should not be deterred from taking a look at the

bands, even if one fears to switch the transmitter on! Looking at things generally, while we are out of the grip of Winter and all that it means in the Amateur Radio sense, it is, to sensitive ears, possible to notice that the bands are opening just a bit earlier, and closing a little later, presaging the full blossoming of Spring conditions, and the DX they bring.

Farewell

Before entering into our monthly look at the bands, it falls to your scribe's sad lot to record the death, on the evening of February 21, of Jack Drudge-Coates, G2DC, after a stroke by which he lost both the use of his keying-hand and his voice. He seemed to lose any wish to go on. Ever since the present writer took over the task of writing CDXN each month, Jack regularly supported us with long and informative letters detailing not only the

DX available on the bands but also his assessment of conditions. Jack was a top-flight operator by world standards, mainly on CW, although latterly he had taken to using SSB on occasion. While Amateur Radio as a whole will sadly miss the G2DC signal, from Top Band to Ten, your conductor's sense of personal loss of a good friend and mentor goes more deeply.

For the record, he was 78 years of age, a Lt. Col. (retired) of Royal Signals and during his long Service career pre-War had himself originated much DX, with exotic callsigns, from such countries as India and the Middle East, where at that time Amateur Radio was quite unknown. *R.I.P.*

Twenty

Let G3UZ (Goring-by-Sea) have the first say; while George's poor old heart bleeds at the sight of his list of gotaways, he has the very

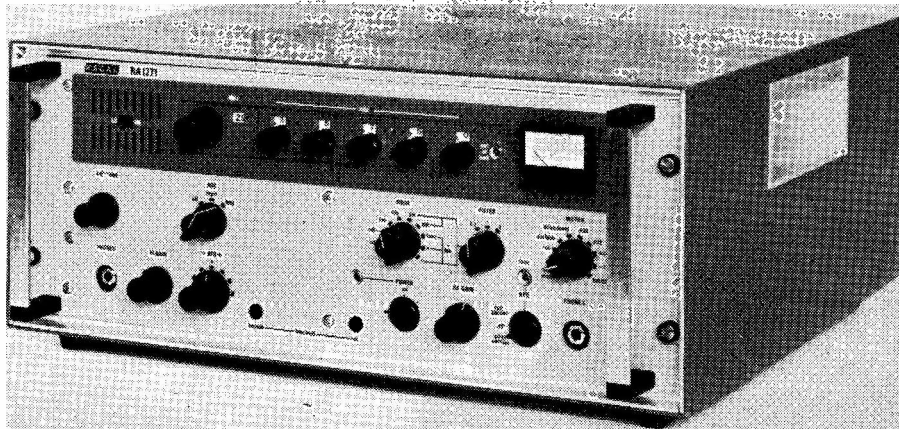

A new commercial all-band receiver for professional use—the RA.1771, manufactured by Racal Communications, Ltd., is a solid-state design covering 15 kHz to 30 MHz in one-megacycle steps, with a decade synthesiser giving 10 Hz readings within each range—the frequency reading as set up in the picture is 29,357.50 kHz. Tuning accuracy is within 5 cycles of the wanted frequency. Modes can be AM/CW/MCW/SSB (either side) or DSB/ISB, the BFO for CW reception giving 3 kHz about tune. High stability is achieved by a frequency synthesiser referred to a built-in frequency standard. Various modules are available at option to provide for specialised user requirements, e.g., FSK for RTTY working, ISB or AFC operation. The muting circuitry is such that the RA.1771 will withstand "splash" input signals of up to 30v. RF at the frequency on tune.

relevant comment to make, that if there was no QSB or QRM to make the going suitably difficult, much of the interest of the chase would evaporate. That the interest did *not* disappear is shown by a CW list including UA9AAG, UA9DW, UA9WAP, UA9SI, UK9MAA, UA9CAZ, UK9HAB, UA9NX, UW9TW, UA9CCC, UI8LA, UH8DR, UKEAE, UL7GAP, UL7GAR, UA0TD, VOIKE, VO1AW, XW8BP, 9H1BT, VQ9M, 9H1AQ, OY1M, 4X4JU, HS3AHL, VE1AFY, FW3SW, PY7BOS, OX3JW, VE1PZ and KV4AA.

After a long silence and a longer personal absence from view, it is nice to see the handwriting of G3SVK (London, E.17) appearing again. Fred's silence is explained by his becoming wed and, later, the arrival of a daughter, not to mention a move of QTH. Like all good DX'ers, Fred was ever a believer in preparation before operation, and so last summer time was spent in laying down plenty of radials and earth spikes in the garden, for the 111 feet of Marconi aerial in use for Top Band, not to mention giving the old 8KW trap dipole something against which to reference itself. As for the machinery in the shack, it is still the same KW-2000A which has given out thousands of contacts from the rarer parts of the British Isles. All that remains, he says, is for him to get off Top Band and *work* someone!

Coming back to the Editor's comments last time on Slow-Scan TV, we have a spirited defence by G4BSU, whose favourite mode this is; he compares SS/TV today with SSB in the 1950's, and gives a run-down on the costs of his (home-brew) SS/TV gear. For those who have been interested by the correspondence, perhaps the most important point G4BSU makes is that 14,230 kHz is probably the favourite frequency for Slow-Scan, to which we could add 21,340 kHz. If, having recorded the noises on either of those frequencies, you want to try your hand at resolving it, a worth-while purchase would be a copy of the "Slow-Scan Television" booklet put out by B.A.T.C., obtainable at 53p post free from G6STO/T, *QTH*.

They all seem to be tackling the specialist modes these days! G3DCS

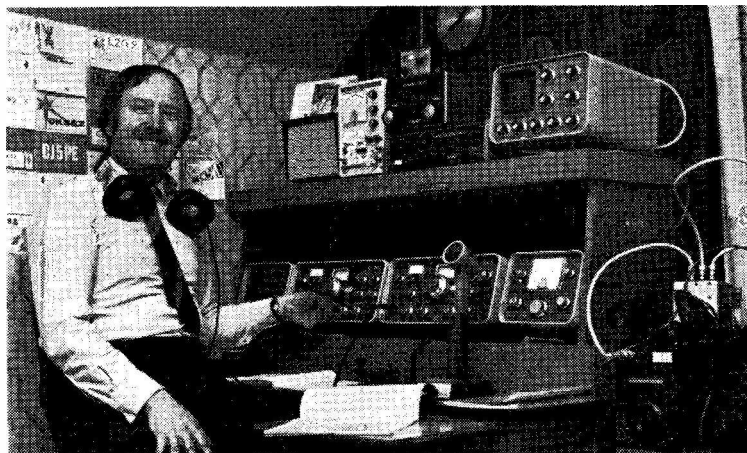

Jack Cresswell, G4AMF, of 4 Hall Street, Hoyland, nr. Barnsley, Yorkshire, passed his R.A.E. in 1971. He is keen on Army Cadet Force activities and operates on the national A.C.F. network. The rig as shown here consists of K.W. gear, with an ATU and a Heathkit signal generator. He also has a home-built digital frequency counter and Z-match for Top Band, where he can often be found.

(Ipswich) returns to the fray, Enver having for some time been engaged in mortal combat with a Teleprinter and TU on Twenty. Somewhat wryly, he remarks that he has progressed from printing "The quick brown fox jumps over the lazy dog" to occasionally receiving "Now is the time to come to the aid of the party!" *Real* progress, that. On a more serious note, Enver has successfully copied RTTY signals from W, UB5SR and ZS3B, although the fact that his machine is set for 50 bauds and some stations run a bit slower has caused a few complications. On a different tack, G3DCS has realised the possibilities in an RTTY TU for QRM-free CW reception using the filters therein—which is a thought that offers interesting possibilities, used in conjunction with a tone oscillator. By way of normal mode contacts, the recent contest provided a string of W's on Fifteen and Twenty, but, alas, no new countries.

G3VLX (Chislehurst) has had a change of rig, the new box being a K.W. Atlanta, whose extra bit of power seems to help in raising the stations. One notes SSB QSO's with CR6TP, ZS6AUL, PY2DVH, ZP5CF, VU2EJ, 4S7SW and 7X2BK on Twenty, the ZP being an all-time new country on any band.

For W6AM (Palos Verdes Peninsula) there were SSB contacts with ZS2AA, 1S1A (Spratley), ZD9DC (Gough), YK1AA, MP4TBM, SV0WK, VK0WW, XT2AF, XT2AF and VQ9M. CW was not neglected, with QSO's registered with 1S1A, and DM2AWO/A in East Berlin.

For G3ZPF (Dudley) it was a lean month with examinations and the preparations therefor taking almost all his time, saving a part of a couple of weekends—however, David reckons that when he has passed them he'll be laughing all the way to the bank! The short spell on Twenty yielded SSB contacts with ZC4DS, 9C9MJ, SU1MR, A4FA, YS1FQM, CN8CG, IC8FMM, HI8XIK, IV5ZWY, FO8AU (who qualified as the catch of the month) 4W1BC, W1, W2, W4, W8 and VE8CK.

GW4BLE (Newport, Mon.) has now had the go-ahead from the authorities for normal working (*i.e.*, he is TVI clear) but is still playing things with some degree of caution. At the time of his letter, only one day of operation had been possible, but what the offering lacked in quantity was made up for in quality, four of the following being new ones for him—FG7XL, M1C, VQ9HCS, VQ9R, 4X25UF, 9H1BX and 9V1RL, all of them being taken

on SSB.

The trouble, says Ted, G2HKU (Sheppey), is that he likes working non-DX stuff too much. Add to that the fact that the grass is already too long, the weeds are "sharpening their teeth," the fish are making noises, and the male blackbirds in the garden are courting—so the gardening will soon reduce his DX'ing time still further! It was not quite as bad as that, really, with SSB contacts to IT9GCQ, SV0WW, ZL1AWI, ZL1VN, ZL3RS and ZL3SE.

There is quite a story to account for the absence of G3DNF (Leeds) from these pages for such a long time. Gordon, it seems, managed to

BRIEF DX DATA

A51PN	Pradhan is QRV on 14295 kHz, SSB around noon, with FT-101, FT-2100, and dipole.
VE8DJ	Is in Zone 1, Dave McKerrow, asking for QSL's by way of VE3DAM.
VR1AA	Is going on leave, and will by publication date be QRT, but expects to return in September for another 2-year tour.
VQ9HCS	Also QRT, but says he will be operating from Astove and Farquhar after he returns.
YA0CDRC	Box 279, Kabul. Favoured spots seem to be 21316 kHz or near around 1030-1230z, and 14285 kHz at about 1300z.
ZS2MI	Leo has been heard on 21316 kHz at 1410z, working to a list by ZS6LW, who is his QSL manager. Also 7084 kHz at 2100z.
1S1A	HS3DR and the boys made 4432 QSO's from Stratley; credit goes to the S.E. Asia stations, VS6DR in particular, who kept 24-hour watch on 7085 and 14342 kHz, during the journey both ways, in case of any emergency.
7P8	7P8AC is understood to be going QRT, but expects to be QRV in about a month from 3D6-land. QSL via W2GLU.

Reporting the HF Bands

scrape up the cards for his DXCC, and duly got the sheepskin. He then gave up DX for the while in favour of trying to learn the knack of transistor RF amplifier design and construction to produce *docile* transmitters—he has now emerged from his hibernation with 1½ watts of transistor RF on Fifteen, after a first essay with ten semi-conductorised watts on Top Band. Having proved his 21 MHz box to work on the long-wire, Gordon then pulled the wire down in favour of a two-element collinear, end-fed, aimed on the States. He is now hunting QRP DX on the basis of "milliwatts per mile" as a figure of merit, and promises more reports in due course. Even on the longwire, contacts have been made with W1QMY, UK9CAE, and PY7AES with good reports.

This Heathkit QRP transceiver, the HW-7, seems to be causing quite a wave of QRP activity, if the reports coming in from G2NJ of Peterborough are anything to go by. Nick mentions G3KPT as having made two QSO's so far with U.S.A. on Twenty running all of 2.5 watts input, and ON4TA with his 700 milliwatts as having worked UW1YY, UK1CUA and UK3DAA.

A late flash from G3VLX shows that Deryck has again kept up the pressure, with more SSB booked in, to FG7TG, HKCCW, EA8HH, CO8QS, PZ1BC, YV5AVX.

Fifteen Metres

A band which its supporters always claim to be far better than Twenty when the two are equally lively, due to the lesser amount of QRM. Maybe they have a point.

G2YL (Tadworth) recently returned from her trip to S.E. Asia, where she met 9M2DQ and his wife, and had a very pleasant few hours there, working G8LY, G5AFA, and G6RC on Fifteen from James's shack, and also meeting 9M2FR.

G3ZPF, as already mentioned, found time short while preparing for his exams, but he did put in a little effort on Fifteen, to work

SSB with FL8DS, GD3FXN, VP2VAM, VK6HE, HR3AC, 3E1KC, EP2SP, W1, W2, W3 and W4.

W6AM doesn't make a meal of 21 MHz, preferring 20m. as his favourite (as all leading DX'ers do) but Don doesn't miss much of what goes on, and he raised W1YRC (QSL Manager for the 1S1A expedition), JD1AHC in Marcus on both CW and Phone, and 1S1A on Spratley.

Not content with registering a new country on Twenty, G3VLX did the same trick again on Fifteen, where we note TI2KF, ZS6HY, PY1DAB and ZE7JC, the latter being the new one. In addition, a later report mentions HC2TV, LU3DJS, LU1DAB, ZP3CA, YV5BPH and WA0GEV, the last two being a struggle in Spanish with the aid of a *Ham's Interpreter!*

Ten Metres

As has been indicated in these pages before, Ten has not by any reckoning disappeared from the DX scene, although it is true to say that the long-distance openings are more North-South than in any lateral directions. G3VLX does not neglect the precaution of at least having a look to see if anything is buzzing, and his new K.W. Atlanta rang the bell with 9J2WR and CR7AF.

Ten is not a usual band to hear from G2HKU about, but it sounds as though Ted must have chosen the right moment to have a look at it; the peep resulted in contacts with EA8URE, ZC4BI and 9J2XZ, all SSB.

During the course of some TVI tests with the Post Office people, GW4BLE noticed the band was open to South America, around 1830z, and on the following day TU2DF was worked in the Ivory Coast, at RS-54 both ways.

About Eighty

To cope with the QRM, particularly at the DX end of the band, needs fortitude of no mean order,

particularly when a certain duck is going through the motions of dying very audibly all over the channel, complete with chorus from the whistler's mother-in-law. However, life is more peaceful down at the CW end, and here what little time on the air was available to G3RFG (Henlow) was spent, giving CW contacts with CO2JY, K2PXX, K2SIG, W1FTX, W1GFT, W1YWV, WA2LGX, WA2LQZ, W4WRY, WB4HQE, W9WKU/4 and W9BR, just to prove Stan had not lost the knack.

A favoured frequency with the W's for 80m. DX'ing is just above our upper limit—say 3802-3804 kHz. Here, W6AM prowled on occasion, and Don was rewarded by SSB QSO's with 1S1A, YJ8GH and KG6JBO, while the DX segment at the CW end served for contacts with VS2SAB and again 1S1A, who was therefore rung up on four bands, CW and Phone.

Eighty seems to have an attraction for G2HKU—at least, this month!—as Ted worked HK3LT, YV2OE, YV5BTS, K3GJD/P3, 9H1BX and 9H5C.

The regular early-morning stint on the band which has been the practice at GW4BLE did not turn out too well this month, and the only ones considered by Stephen to be worth noting were contacts with VE3BBM, ZL4KF, KP4DHD, PJ2CW, VP2MY, KZ5JF and W1-2-3, all around 3790 kHz between 0700 and 0800z.

Forty Metres

This seems to be a band on which no DX could possibly be worked—unless one is provoked into trying it seriously! Apart from a reasonable aerial (say, a ground-plane at roof-height with a fair take-off) the main requirement is undoubtedly an RF attenuator for the receiver, or a near-perfect first mixer stage to hold the unwanted noise generated by all the megawatt-commercials around and in the band to a low level at the frequency you actually want. Do that, and the DX is there for the calling, both CW and SSB, but for the average receiver used in the ordinary way, with full RF gain, they just get buried in the noise.

G3VLX had an early 40m. session one morning, and heard VK2ALK calling CQ. Deryck called him, and

to his surprise raised the VK. As if that were not enough in the way of surprises for one morning, at the end of the QSO, G3VLX in his turn was called by VK2AVA! Both the VK's had two-element beams up, but G3VLX runs a thin-wire inverted-Vee made up of 26-gauge wire strung up with terylene sewing thread. As the contact was surely long-path, the distance must run all of 14,000 miles.

By way of G2NJ, we hear that ON4TA has continued his QRP work on the band. When one considers the noisy state of it most of the time, it really is amazing just what he can do—Phone at RS-57 with G8PT on one watt, while 700 milliwatts of CW was enough to make solid contacts with GD3FBS and F9OV. Another enthusiast for QRP is G3GQE, who worked G2NJ on one watt of Phone for a solid 57 report.

Top Band

G3SVK has been, as mentioned elsewhere, less active of late for various reasons, but eventually the old bug bit deeply again, and his 111 feet of wire, of which 38 feet is vertical, was loaded up on Top Band. So far the score is G, GW, GM, GD, G1, EI, DL, OK, OE, HB9, W, KV4, VE, VO, and PA0. That leaves at least six European

countries available to bring the score up to a round twenty countries. The reports from over the Pond have been quite fair, averaging around RST 569. In the intervals, there has been the more local pleasure of working the FOC members to be found on Top Band, to keep his hand in.

For your conductor, the event of the month was when 5Z4KL was heard on 1803, bobbling in the noise at 229, and apparently with no-one hearing him well enough to justify a call. However, a SWL report on the circumstance yielded a quick return QSL from André, which at least proves that despite what some people say, G3KFE's one remaining useful ear is not all made of cloth!

Tit-Bits

Last time, we mentioned that G3RFG was wondering who was the oldest active amateur. A reader (we can't read his signature!) says he has a letter from VE1LG, who, at the date of his letter back in 1969, said he was 94 and still operating; which would make him 98 now!

Jock Perrett writes to say that having been on leave from 5Z4-land, he is now ready for the "off" in Malawi, just so soon as the rig arrives—it is expected about the time this piece was being written up—when he will be signing 7Q7DW,

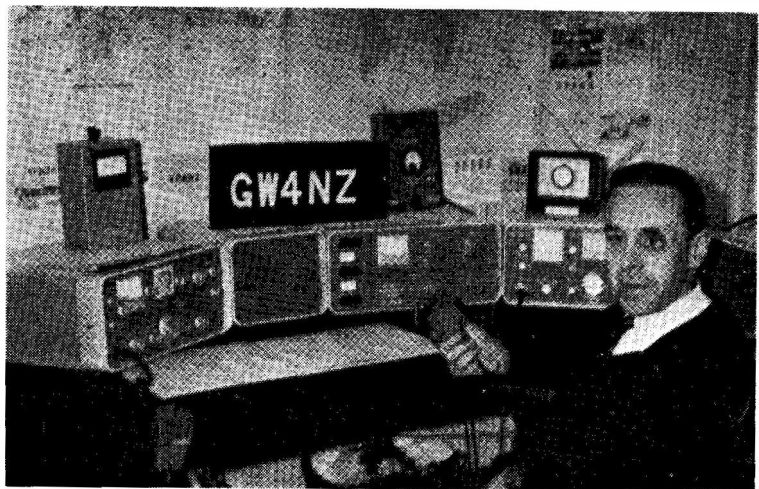

GW4NZ, Syd Roberts, licensed pre-War, runs K.W. equipment, with ancillaries, and is at 70 Cimla Road, Neath, Glam., South Wales—this is also his QSL card.

with an FT-101, first to a 5RV aerial, and then, when the bamboos are dried out, to a Quad. Oddly enough, another station is starting up in Malawi—ex-9J2KP has also opted for 7Q7 and has his KW-2000 there already, but at the moment of writing awaits clearance of the formalities for the issue of a ticket.

Possibly the most interesting of the competitive events to be noted this time is the **Bermuda Contest**, the Phone leg of which is April 21-22, 0001z Saturday to 0200z on the Sunday. Exchange RST plus your *county*, and you will get back from the VP9's RST plus a parish, the abbreviations for which are Dev, Ham, Pag, Pem, San, Smi, Sou, Stg and War (nine parishes in all). Each completed QSO counts 3 points, the multiplier being the number of parishes worked on each band. (Previous winners *ineligible* for two years for an award). Presentation of the top prizes at the Bermuda Club's annual banquet on October 18—transport and hotel accommodation for a week's stay at one of the Bermudan leading hotels will be provided by the Society! This event, with its astonishingly attractive prize (which must be worth some £100's) will demand some pretty hot operating—it has been won rather too easily in the past, with a small U.K. entry. Logs to be received not later than June 30, at the Radio Society of

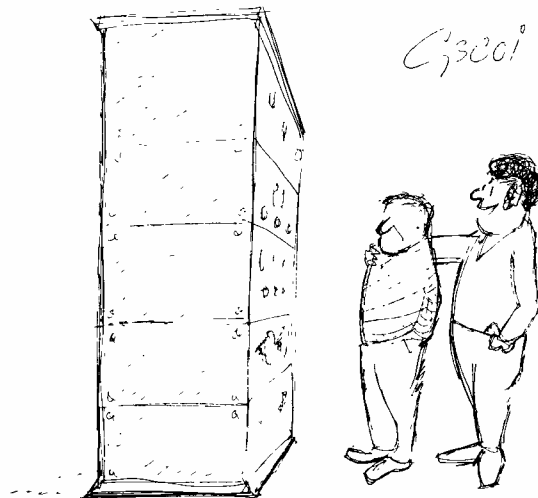

“ . . . “ Yes, OM, it will load into anything—preferably a three ton truck . . . ”

Bermuda, PO Box 275, Hamilton, Bermuda.

Conclusion

That is that, for another month at least. If anyone wrote in to CDXN, and has not had a mention, it will be because of mail dislocation due to the rail chaos—the mail inwards was running very late, and to meet the deadline your conductor had to clear this early—a form of two-way squeeze on him! For next time, the deadline will be **April 10**,

latest addressed as always to: “CDXN,” SHORT WAVE MAGAZINE, BUCKINGHAM, MK18 1RQ.

Closing dates for the next few issues will be **May 8**, **June 12**, **July 10** and **August 14**—these are all Tuesdays, and are final dates to catch this feature. If you write from overseas, allow at least five days by airmail. If from the U.K., two days first-class posting. We cannot take in late reports.—*Editor*.



The new Redifon “Omega Navigator” receiver will give a ship positions accurate to within about one mile on ocean passages across the world. It is, of course, a satellite-referred device and is now installed in the new ship m.v. “Orbita” of the Pacific Steam Navigation Co., Ltd.

SIDEBAND TRANSVERTER FOR TWO METRES

SOME RELEVANT DETAIL
DRAWINGS —
SETTING-UP PROCEDURE

J. D. V. LUDLOW (GW3ZTH) and
C. J. DUNBAR (GW8EHK)

Part II

GOING on now from p.31, March: Remove the PA valve, close RL1 and check that the buffer amplifier anode current is within its ratings for the safe anode dissipation. Should all be well note the mixer anode current—this should be a nominal 24 mA. With Tc3 resonated, V5 anode current should rise to about 30 mA. Reduce this to around 28 mA by loosening the coupling between L6 and 7. Then insert some 28-30 MHz carrier from the SSB prime mover until the anode current rises by one or two milliamps. Resonate Tc4 for maximum output over 144-146 MHz—measured by means of an absorption wavemeter. At this point the 116 MHz component should be at a much lower level at the mixer anode. The alignment of the buffer amplifier is straightforward—adjust the coupling between L8 and L11 for maximum output. Should the buffer amplifier run into grid current reduce the coupling until the valve draws no grid current. With the buffer connected to a dummy load *via* a reflectometer adjust VC2 for maximum output—connecting it back into the PA grid circuitry when this has been com-

pleted. After ensuring that all supplies have been removed, insert the PA valve into its socket and attach the anode connectors—allow a minute or so for its filaments to reach their operating temperature and then establish the supplies momentarily, noting the standing anode current; with 600v. on the anodes this should not be more than 30 mA—set the PA bias pot. until this figure has been reached. With no 28 MHz injection rotate the PA tank circuit controls; there should be no sign of instability—the PA anode current should remain at its preset figure. Increase the standing anode current momentarily, by means of VR1, to say 100 mA and repeat the exercise; the PA stage should not show any signs of instability under any condition—should it do so this will have to be rectified before going on any further.

If all is well connect a dummy load to the aerial socket *via* a reflectometer and apply some 28 MHz carrier; adjust the buffer amplifier, PA grid circuit and PA tank circuit for maximum forward power as indicated on the reflectometer. Increase the PA HT to 800v. and the carrier level until the PA anode current reaches not more than 200 mA and re-check the tank tuning and loading; the optimum position for the link is slightly over-coupled past the point of maximum output. The output should fall to zero in sympathy with the reduction of the inserted 28 MHz carrier. Finally, connect the antenna to the transverter through the reflectometer and bandpass filter and repeat the loading instructions; switch to USB with the SSB prime mover; set to 29.41 MHz and it should be possible to raise someone locally to check out the signal for you.

Band-Pass Coupler (p.91)

In Fig. 4, the band-pass coupler between the PA and the driver is as shown, using either a *Denco* Maxi-Q DP5 blue-range coil or the home-wound version can be

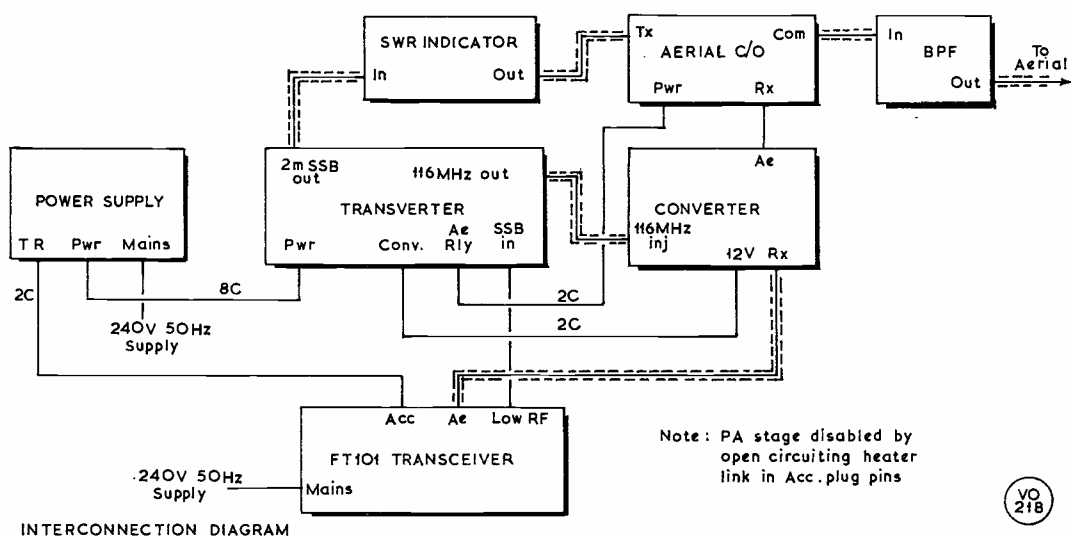

INTERCONNECTION DIAGRAM

Interconnection diagram with FT-101 as prime mover.



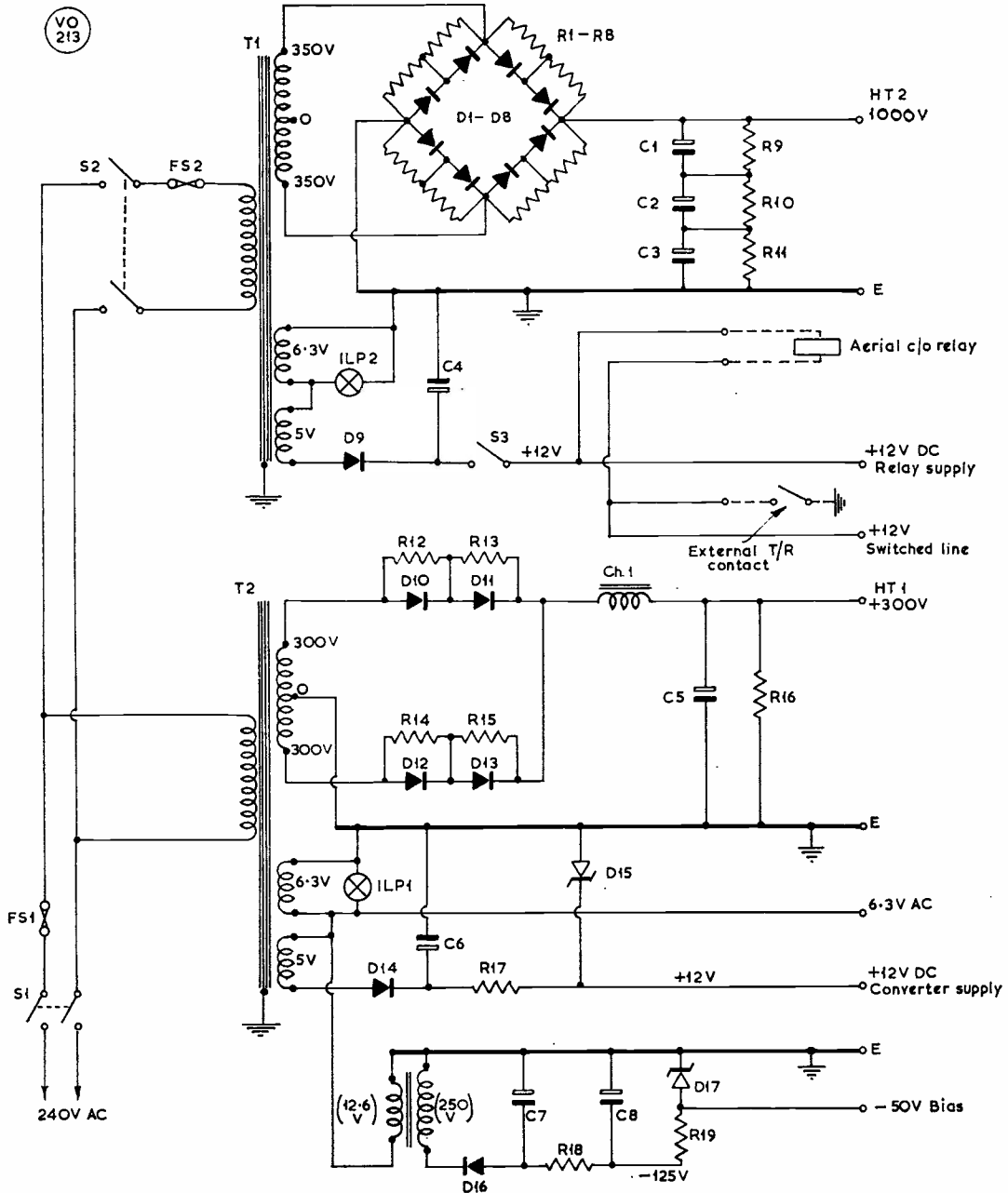
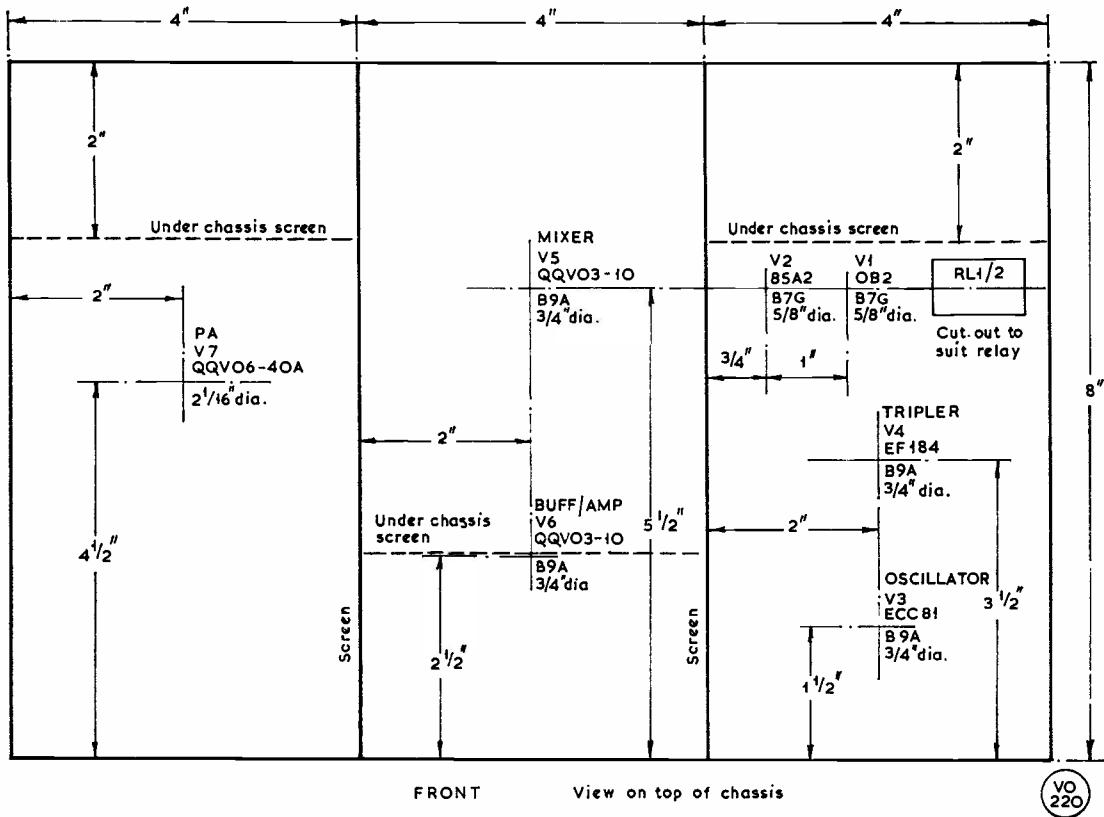

Fig. 2. Transverter Power Supply circuitry



Layout of Transverter, showing placement of major components on 12 x 8 x 2 1/2 inch chassis.

Table of Values

Fig. 2. Power Supply Circuitry

C1, C2, C3, C5 = 100 μF, 450v.	D9, D10, D11, D12, D13, D14,
C4, C6 = 500 μF, 25v.	D16 = BY100, 1N4006
C7, C8 = 32 μF, 350v.	D15 = 12v. 1w. zener
R1, R2, R3, R4, R5, R6, R7, R8, R12, R13, R14, R15 = 270,000 ohms, 1w.	D17 = 50v. 1w. zener
R9, R10, R16 = 150,000 ohms, 2w.	T1 = 350-0-350v. 150 mA, 6-3v. 1A, 5v. 1A.
R17 = For 12v. supply	T2 = 300-0-300v. 150 mA, 6-3v. 4A, 5v. 1A.
R18 = 270 ohms, 1w.	T3 = 12-6v. heater xformer
R19 = 680 ohms, 2w.	FS1 = 1-5 amp fuse
Ch1 = 10 Hy 150 mA choke	FS2 = 850 mA, anti-surge
D1, D2, D3, D4, D5, D6, D7, D8 = BY127, 1N4007, or similar 1,000v. p.i.v., 1 amp.	

Notes: All resistors are carbon. Transformers have standard primaries, or as required. T3 is reverse-connected. Condensers C7, C8, should have cans insulated. S1, S2 are DPST and S3 SPST, all toggle rated 250v. 3 amp. Indicator lamps are 6-3v. 300 mA.

used. This can consist of a primary of 6 1/2 turns of 22g. enam., spaced wire dia., on a 3/8 in. dust cored former; for the secondary, two turns of the same over-wound at the cold end of the primary. The coil is set-up by arrangement of the core.

Results and Observations

Every transmitter emits some spuri, even professionally designed and constructed commercial ones. The G.P.O. requirements lay down that not more than 2.5 μW may be emitted outside the pass band of the channel in use; this is better than 80 dB down on 25 watts so we should aim for 90 dB or better. To achieve this it is recommended that the xtal oscillator chain starts off with a VHF xtal such as 38-666 MHz or 116 MHz; avoid 29 MHz as the 5th harmonic comes up in the band; also avoid 58 MHz because the 2nd and 3rd harmonics would generate two inband mixing products from the 10-metre drive signal. Further, use a 28-30 MHz band-pass coupler between the SSB prime mover and the transverter input socket. Keep all interconnecting leads short. Recently, the '3ZTH signal was copied locally on 10 metres due to a 4ft. length of coax from the FT-101 to the transverter. At least five bandpass coupled circuits between the mixer and antenna should be employed and

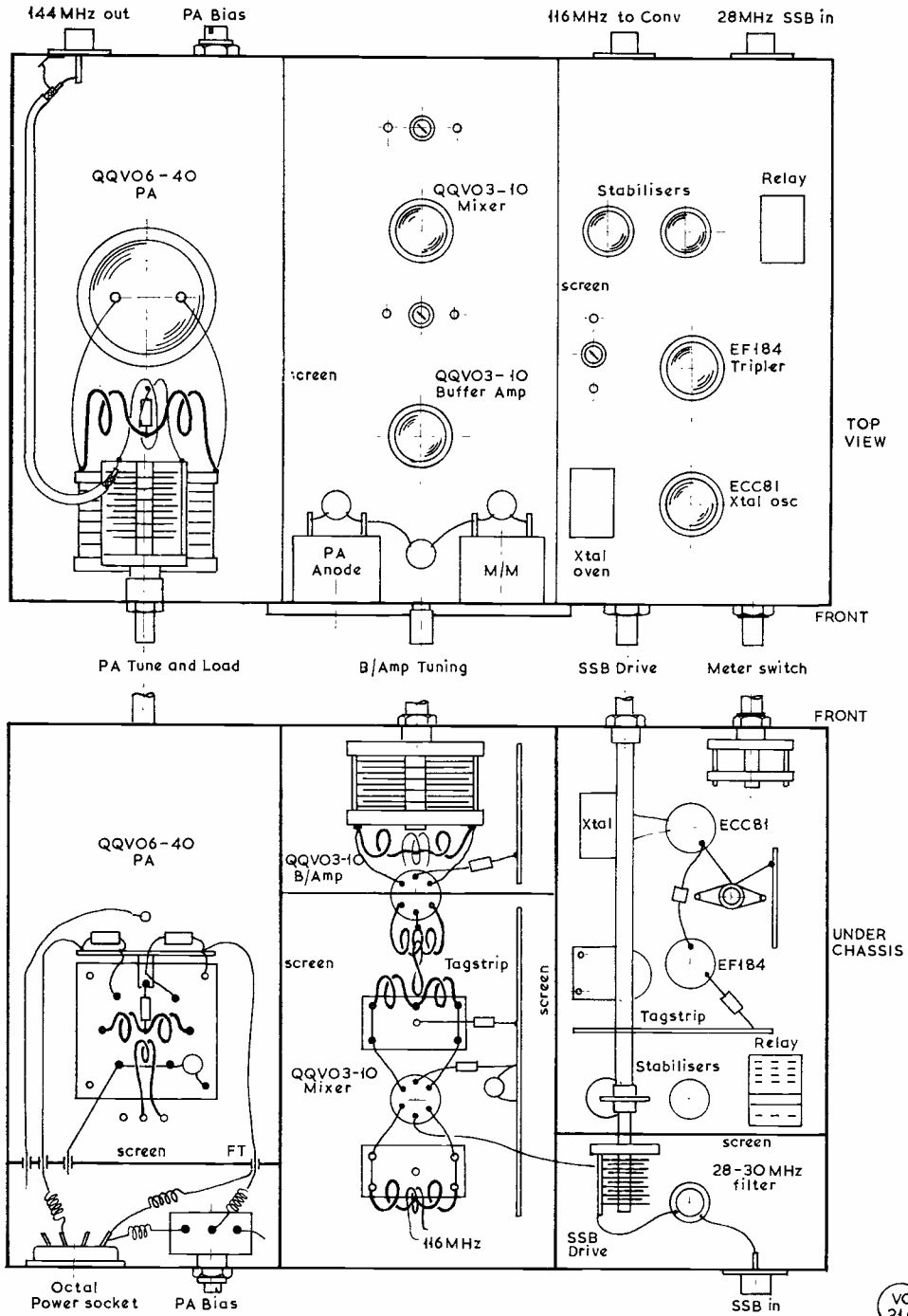

Fig. 3

VO 216

Construction underside of Transverter chassis

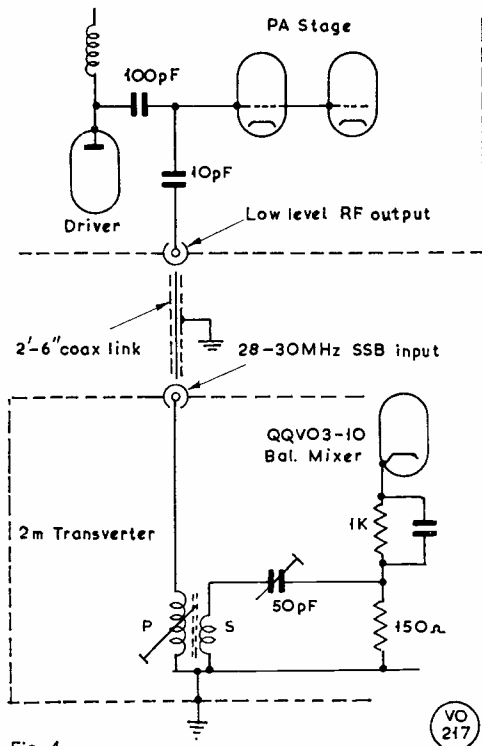
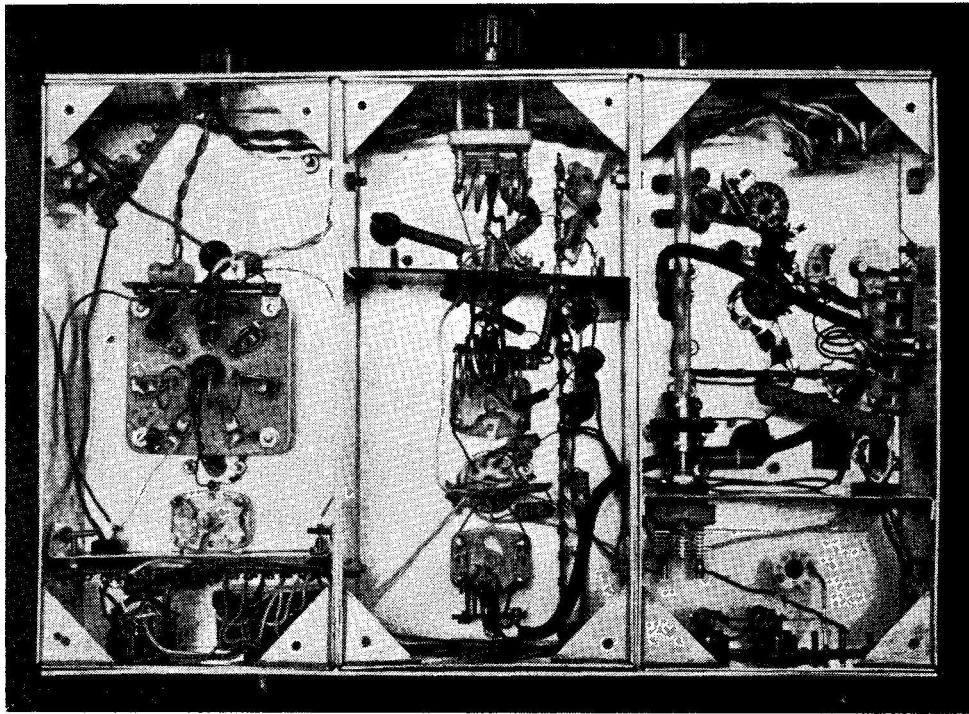

Fig. 4

VO 217

Under the SSB Transverter with QQVO6-40A PA base at left. The balanced mixer/buffer amplifier chassis is at centre, with BA section above the mixer—note screens across valve-holders. The right-hand screened enclosure accommodates the oscillator/tripler chassis.

the use of a bandpass coupled filter between aerial and transverter is also recommended. These precautions should reduce any spurs to an acceptable value.

What about the inband ones? The use of a HF filter rig is highly recommended. Beware of SSB transceivers with 465 kHz filters because the discrimination against the image at 10 metres is very poor. If you must use such a rig employ additional tuned circuits between the SSB prime mover and the transverter. Local splatter can be a problem—avoid overdriving the mixer and succeeding stages, linearity being the watch word to produce smooth output.

The transverter as described here has now been in use continuously for six months and no serious problems have been encountered. In this period twelve countries and fifty-nine countries have been worked. Compare this with your logs over a similar period and remember this has been obtained from Glamorgan—a notoriously poor VHF location.

When using a KW-2000 type transceiver as prime mover, a dummy load must be provided, capable of dissipating much of the RF output, e.g., 13 one-K 5w. carbon resistors in parallel. This load should be canned, with an oil filling. (See G3FCW article, p.95).

Diode protection will also be needed on the IF

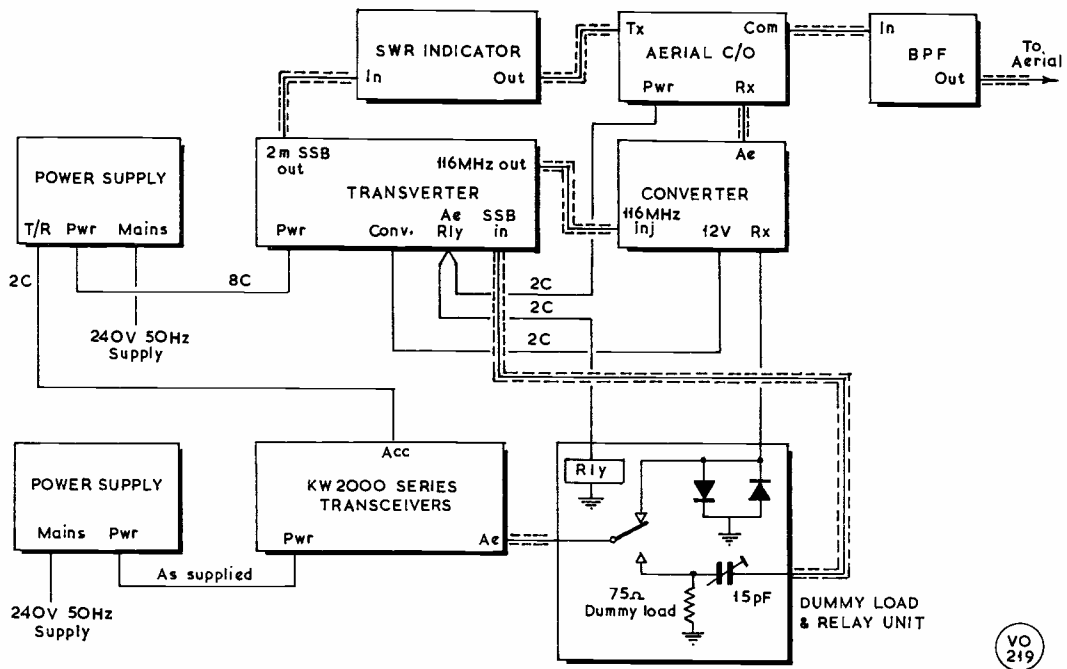

INTERCONNECTION DIAGRAM

Interconnection diagram with transceivers of the KW-2000 series as prime mover.

transformer link to safeguard the mixer FET.

Editorial Note: We understand that several models of this Transverter have been constructed and that all have performed very satisfactorily.

CO-ADAPTOR BELLING/BNC

To complete the story on p.28 last month, a Belling Lee-to-BNC-adaptor is also quite a simple job. Ream out the cable entry end of a B/L plug to take the threaded portion of the back nut from a BNC plug. (Note that the BNC plug with a dimension of $\frac{3}{8}$ in. across the flat of the nut is required.) To the spigot of the B/L plug solder a piece of insulated wire, to the other end of which the spigot from the BNC plug is soldered so that the total length from tip to tip of the two spigots is two inches. Drop over this wire four $\frac{3}{8}$ in. diameter washers and screw the back nut of the B/L plug into position. The threaded portion of the BNC backnut now protrudes from the end of the B/L plug and the body of the BNC plug is screwed to it.

The diagram shows the assembly. *A.H.D.*

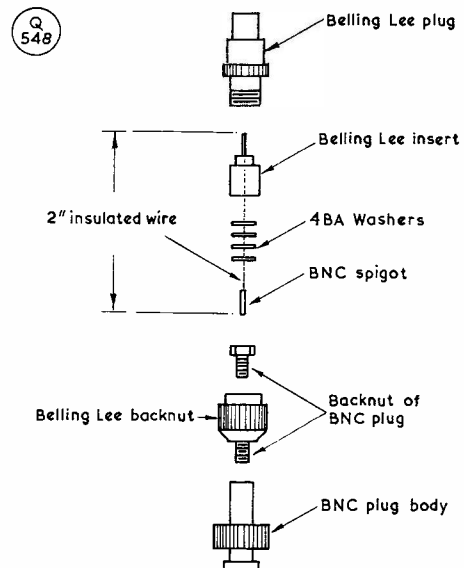

To keep in touch with the world of Amateur Radio, read "Short Wave Magazine" regularly

FRONT-END TUNING

TO REDUCE CROSS-MODULATION —GETTING RID OF THE HASH ON FORTY

R. A. PENFOLD

THE 40-metre band is somewhat neglected by many amateurs and SWL's. There are probably two main reasons for this, (1) For G's, the band is only 100 kHz wide, and (2) It is next to the 39-metre broadcast band, some BC stations actually transmitting on frequencies within 7.0—7.1 MHz.

It is this 39-metre band, and the broadcast stations in it, which are the main cause of the trouble, as this produces an abnormally high degree of cross-modulation in the receiver front end. This can in turn result in weak DX stations being lost in the noise. Many of the older-type receivers are virtually useless on Forty at times, due to the rather old fashioned front-end circuitry which they employ.

Cross-modulation is a form of intermodulation distortion. This type of distortion occurs when two or more signals are passed through an amplifier with non-linear characteristics. The effect of the distortion is to reproduce the sum and difference frequencies of all the various input frequencies. The level of the spurious frequencies is proportional to the extent of the non-linearity of the amplifier, and the strength of the applied signals.

Most of the frequencies produced by cross modulation lie well outside the passband of the receiver's front end, and can therefore be disregarded. Certain frequencies produced will, however, fall within the front end's passband, and it is these which cause the interference. Fig. 1 shows how two frequencies when cross modulated can produce such frequencies—and also how this distortion can hinder the reception of weaker signals, even though the two frequencies which are

producing the distortion lie outside the IF passband of the receiver (they must of course lie within the passband of the receiver front-end). The diagram shows the distortion products produced by only a single carrier-wave, and one modulating frequency. Actually, there would be several carrier waves, and possibly some *thousands* of modulating frequencies! Thus, many thousands of new frequencies would be produced, these sounding rather like ordinary background noise from the receiver, except that the level of the noise will vary with the modulation levels of the offending stations.

Adding an ATU

To reduce cross modulation it is necessary to overcome distortion in the receiver RF and mixer stages. If the receiver is of an older type, replacing the front-end valves with modern miniatures may help a little, but there would still be problems with cross modulation, as no front end is completely distortion free. An attenuator can be added between aerial and receiver, and this will reduce the strength of the signals at the input, and thus minimise the risk of over-driving the front-end stages, therefore also reducing cross modulation.

This means that the level of the required transmission will also be reduced, although an attenuator would give an apparent improvement in performance.

Another method of reducing cross-modulation is to put in an aerial tuning unit, which will reduce the RF bandwidth of the receiver. Thus, unwanted signals are attenuated before they reach the receiver, the required signals being virtually unaltered in level. This also gives greatly improved image rejection to the receiver.

In order to obtain a sufficiently narrow bandwidth, the ATU requires at least two tuned circuits. To reduce loading so as to obtain high-Q, a fairly loose coupling needs to be used between the two tuned circuits.

The circuit diagram of an ATU constructed by the author to meet these requirements is as Fig. 2, p.94. L1 is the aerial input winding, which couples the input signal to the first tuned circuit, L2. The second tuned winding is L3, this being coupled to L2 by the low value capacitor, C2. Capacitors with values as low as C2

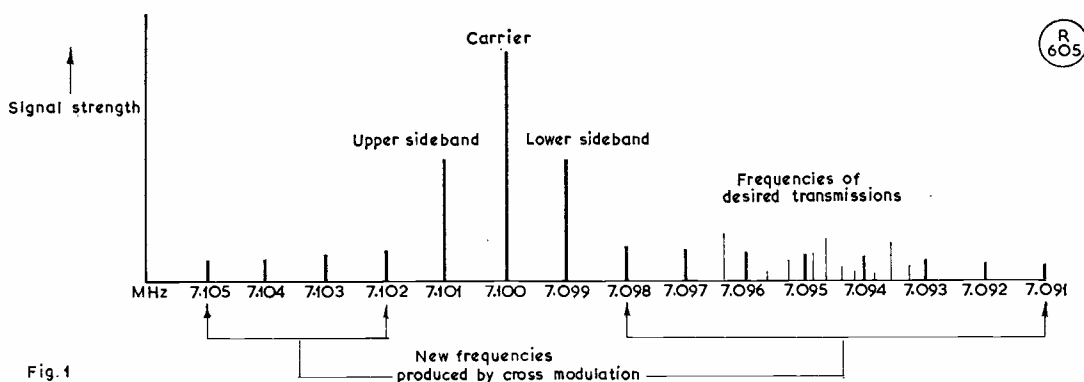

Fig. 1

Fig. 1. Showing new frequencies ("beats") produced by cross-modulation and interfering with desired transmissions.

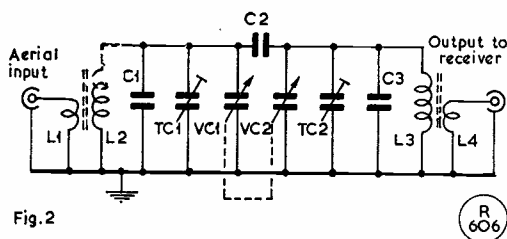

Fig. 2

Fig. 2. Circuit of the front-end tuner described in the text. Values can be: C1, C3, 180 pF, silvered mica; C2, very small capacity, 1.8 pF (see text); TC1, TC2, 10-80 pF compression trimmer; VC1, VC2, 25 + 25 pF air-spaced two-gang tuning capacitor; L2, L3, 20 turns 30g. enam. on *Denco* or similar coil formers with B9A base, and fitted with ferrite cores; L1, L4, 4 turns 30g. enam. put on adjacent to L2, L3.

(1.8 pF) are difficult to obtain, although they are available from some of the larger component retailers—but C2 could be contrived by twisting together two short lengths of insulated wire, say half-an-inch.

The output from the ATU is coupled to the receiver via the low impedance winding, L4. C1—TC1—TC2—C3 are used to adjust the two tuned circuits to the centre of the 40m. band, with VC1/VC2 at half maximum capacity; these then tune the unit to the desired area of the band.

Construction

The prototype was built on a home-made aluminium chassis measuring 5 x 3 x 1½ in., fitted with a front panel of 4 x 3 in. Coax sockets mounted on the rear of the chassis are used for input and output. Coils L1-L4 are wound on a couple of *Denco* ¾ in. diameter formers, which have bases to plug into standard B9A valveholders. The two coils are identical: L2, L3 consist of 20 turns of 30g. enam., and L1, L4 are of 4 turns, wound immediately above L2, L3. To ensure rigidity the windings should be glued to the former using polystyrene cement, or a similar adhesive. The two coils should be fitted with the appropriate ferrite cores.

Other Points

A simple point-to-point wiring system is used. The cable between the ATU and the receiver must be screened for the unit to avoid direct pick-up.

Such an ATU can of course be operated on other bands providing the inductance of the tuning coils is altered to suit the desired band. The unit is, however, likely to give less benefit on other bands—with the exception of perhaps Top Band, which we share with powerful maritime transmissions, and lying near Medium-Wave broadcast band.

On our HF bands, such a front-end unit can give a very noticeable increase in the image rejection of a superhet receiver having a low frequency IF in the region of 465 kHz.

For correct operation on other bands it will be necessary to adjust the value of the miniscule capacity C2. For operation at double the frequency its value would be halved, while for operation at half the frequency, its

value would be doubled. (Twisted wires will usually do the trick.)

By adding a *third* tuned circuit the performance of the unit can be even further improved. This modification is as Fig. 3 below. The additional coil, L5, is identical to the other two tuned circuits, L2, L3—but careful alignment of this circuit is required for optimum results. You can reach a point where you are juggling with too many variables!

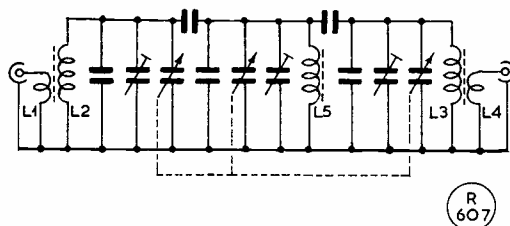

Fig. 3. To increase performance, a third tuned circuit, L5, can be added—as L2, L3—though adjustment and tuning would be more difficult.

RTTY CONTEST RESULTS

For the radio-teletype contest sponsored by the Canadian Amateur Radio Teletype Group over October 14-16, 1972 (results for which are just out), they had 115 single-operator entries from all over the world—but only three U.K. stations are listed: G3OZF gained 16th place, with 199 contacts on five bands 10-80m., his best being 14 MHz (97 QSO's), with WAC gained; G3LDI also worked the five bands, with 76 contacts for 63rd place; and G3RQY came 83rd with 58 QSO's on four bands. The three leaders, world-wide, were ZS3FB, LU2ESB and YV5AS, with astronomical scores up in the millions. All the first 18 stations made over a million points. Some stations used considerable power: YV5AS ran 2 kW; KZ5BH, 800 watts; K4AGC and VE7UBC with a kilowatt apiece are just examples.

INTERESTING CASE—AND A WARNING

It was recently reported in the public print that one Gerald Paul of Pyrford, Surrey, collected a fine with costs of £35 for listening-in on the London Fire Brigade transmissions on VHF. Not content with this judgement, he took his case to appeal and was, naturally, well slapped down by Lord Widgery, L.C.J., who pointed out that the defendant was committing an offence under the Wireless Telegraphy Act—even if his motives were entirely innocent and blameless. The Lord Chief Justice might also have explained that—as we have frequently said in these pages—radio transmissions by many other services (police, hospital, aircraft, shipping and such) are equally protected under the law against eavesdropping by the curious, and that the Ministry will always prosecute where a case can be proved.

INEXPENSIVE DUMMY LOAD

50-OHM NON-REACTIVE —
CONSERVATIVE 50w.
DISSIPATION

G. DENBY (G3FCW)

USE a dummy load? Why bother. This opinion, although perhaps seldom voiced, is thought often enough, if we are honest with ourselves. Putting the transmitter on the air for a (quick) test is the usual practice. And the result? Yet another signal to add to the general QRM. So the band is quiet? Does that excuse the seemingly interminable carrier on two metres?

Not just AT-stations, either. Shore stations have often to instruct ships testing on 500 kHz to QRT. This on an international distress frequency, too. There is seldom a callsign sent, and the station stays unidentified, creating havoc under the cloak of anonymity.

Moralising? Perhaps, but there is merit in being good neighbourly. In keeping your test signals to yourself—in the shack where they belong. Without wishing to “throw the book about,” Clause 4(1) of our Licence does make the point clear. Of course we all mean well,

and many more dummy loads would be used if more people had them. Commercial models are available, too.

Resistors

However, the unit shown here is simple enough to build but does entail the use of non-inductive resistors (*i.e.*, not wirewound). There is no problem if one is only needing to dissipate a watt or two, but tens of watts, and the problem of a large non-inductive resistor becomes apparent. This difficulty faced the writer, like many other people.

A trip into Town one day gave the opportunity to see some normally unfamiliar radio shops, and in one particular window there was this box full of old style large 500-ohm 5-watt carbon resistors, at 10 for 5p—which in turn triggered the almost subconscious Ohms Law calculation that ten resistors in parallel would give 50 ohms of resistance with 50 watts dissipation. 5p never changed hands more quickly!

Construction

The general construction will be apparent from the photographs. If the container resembles a 2 lb. “Golden Syrup” tin this is no coincidence. The tin was cleaned with paint remover and the seams, although no doubt tight, were run over with solder with a 150 watt iron just to be sure.

A hole was drilled in the lid to take the coax socket.

The completed 50-ohm 50-watt Dummy Load as discussed in the text. The whole thing can be built into, say, a “Golden Syrup” tin, or something similar, suitably dished up and containing the heat-dissipating oil—see text.

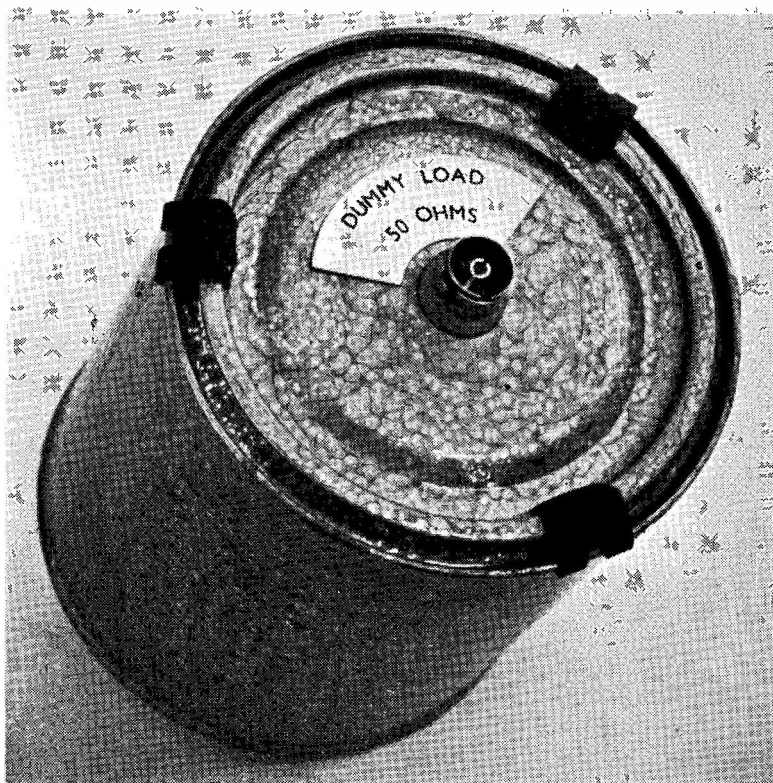

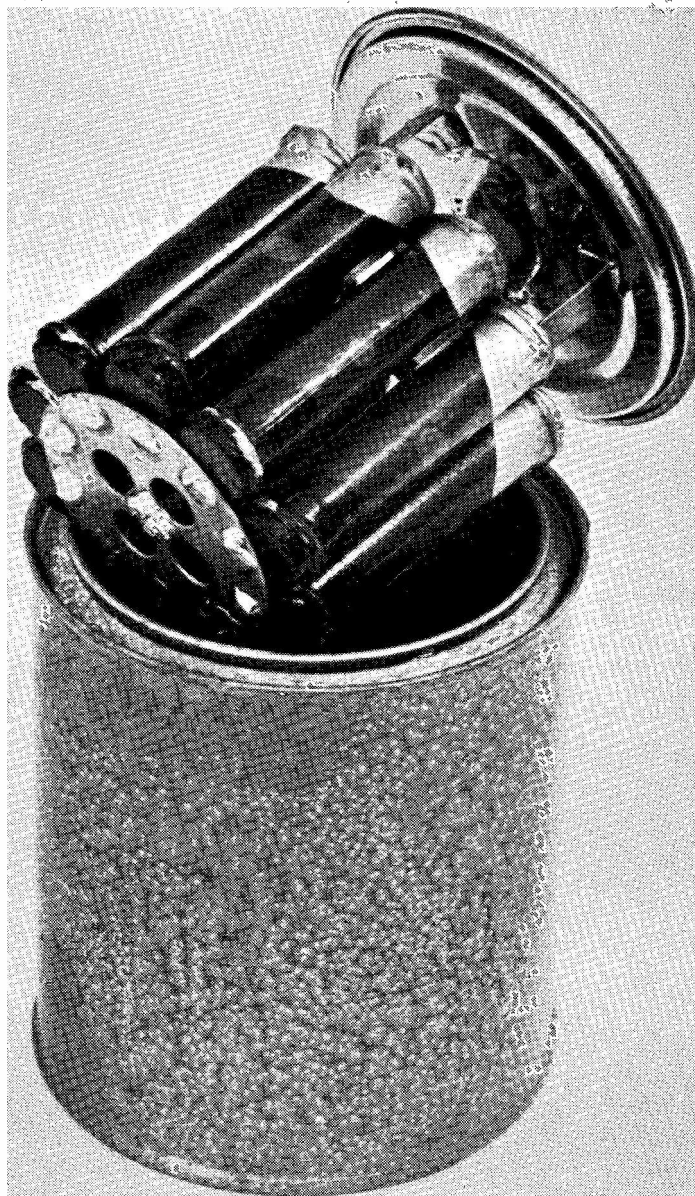

This detail is to show the holes in the bottom disc to help circulation of the oil coolant—which, in this simple application, can be ordinary domestic cooking oil.

The socket flange was soldered to the underside of the lid, again using the large iron, running plenty of solder round to make a seal. It is a good idea to insert a plug in the socket, as the insulation may temporarily soften if the soldering is prolonged, and the plug will hold the socket pin in position. To make sure of a good seal the underside of the socket is liberally covered with *Araldite*.

The resistors are mounted between a 2in. diam. disc

of 22g. copper at the bottom, and a similar sized ring of copper at the top. To make the ring first cut a $1\frac{1}{2}$ in. diam. hole with a socket punch. Brass or tinplate would do equally well, but aluminium is out due to difficulties in soldering. Four $\frac{3}{8}$ in. diam. holes are drilled in the bottom disc to assist circulation of the oil coolant. A length of screening from a scrap of coax cable was used as the connection from the bottom disc to the coax socket. Three lugs are included on the top ring which are

The 50-watt 50-ohm compact load nest as put together by G3FCW. The last (tenth) resistor has not been connected to show the general construction. When completed the assembly is soldered to the underside of the container lid.

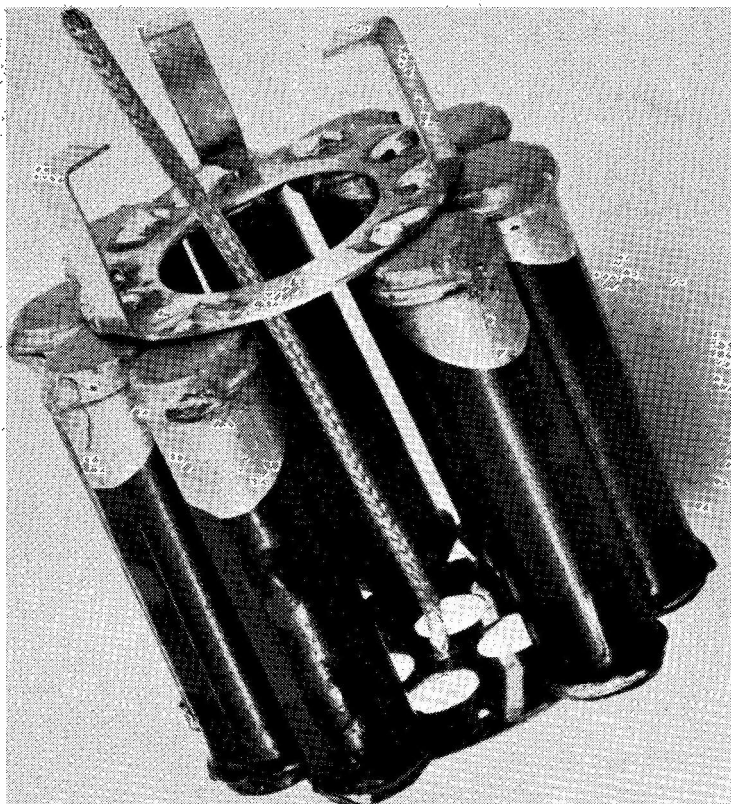

bent up and soldered to the underside of the lid. The tin is then given a coat of hammer finish enamel, and a small label added with dry-print lettering. (The three lid retaining clips were conveniently supplied on the tin of enamel). Discussing this project with fellow members of the Club produced a majority opinion that there should be a vent. No conclusive arguments were put forward, it was just "felt" to be "right". Accordingly, a 1 mm. hole was drilled in the lid opposite the label.

Although transformer oil would no doubt be the ideal with which to fill the tin, it is thought the availability of an odd pint may depend on who your friends are. A more easily obtained product is the ordinary household cooking oil of your favourite brand. Cover the resistors, but leave a little air space under the lid. After all, this oil is intended to work happily in excess of 350°F. and if your dummy load is dissipating sufficient power to fry chips, then the writer would rather not know. Don't tell the man from the Ministry either.

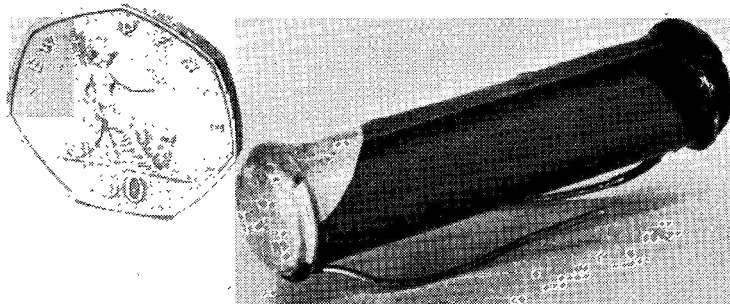

To make up the "soak load" old style 5-watt carbon resistors are the ideal thing. If you've not got them in the junk-box, they can usually be found by shopping around, in either 50 or 75-ohm values—an Ohm's Law computation will determine how they should be connected.

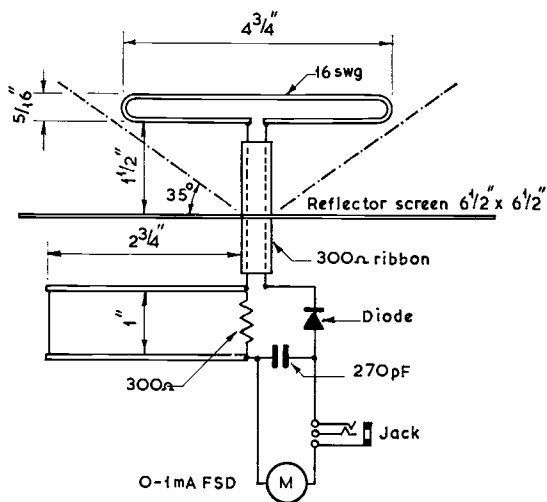

Fig. 1. Circuitry and general construction of the UHF field-strength meter. The wings of the reflector panel can be bent to improve directivity—see Fig. 2.

F/S METER FOR 23 CENTIMETRES

SIMPLE AND EFFECTIVE PORTABLE INSTRUMENT

FOR anyone starting up on 23 cm., some sort of indicator of radiation performance is essential. One cannot just rely upon finding another station on the band when you want one, and, in any case, one cannot expect another operator to spend a lot of his time doing tests for you. The quick, and in almost every way the most satisfactory, answer lies in the Field Strength Meter. The following notes describe a simple device of this kind.

Above is the general scheme. The antenna is a horizontal folded dipole fed by a length of 300-ohm ribbon which also supports it. If desired, the dipole may be supported by a piece of p.t.f.e. rod, but in view of its small size and weight this is not essential. The ribbon passes straight through the centre of a square sheet of aluminium serving as a plane reflector, which in turn is bolted to a 14in. length of $\frac{3}{8}$ th dural tube, the lower end of this being screwed into a suitable base plate. (If you can run to thin brass or copper sheet, so much the better.) Immediately behind the reflector one end of the ribbon is connected to a xtal diode and the other to a 300-ohm resistor, the purpose of which will become apparent later.

The output from this network, after suitable decoupling, is fed *via* a hole in the dural tube down to the base of the instrument. A 500 microamp or 1 mA meter is used as the indicator, and this is mounted on a strip of p.t.f.e. by means of its own terminals in such a manner that it is free to revolve round the bottom of the dural

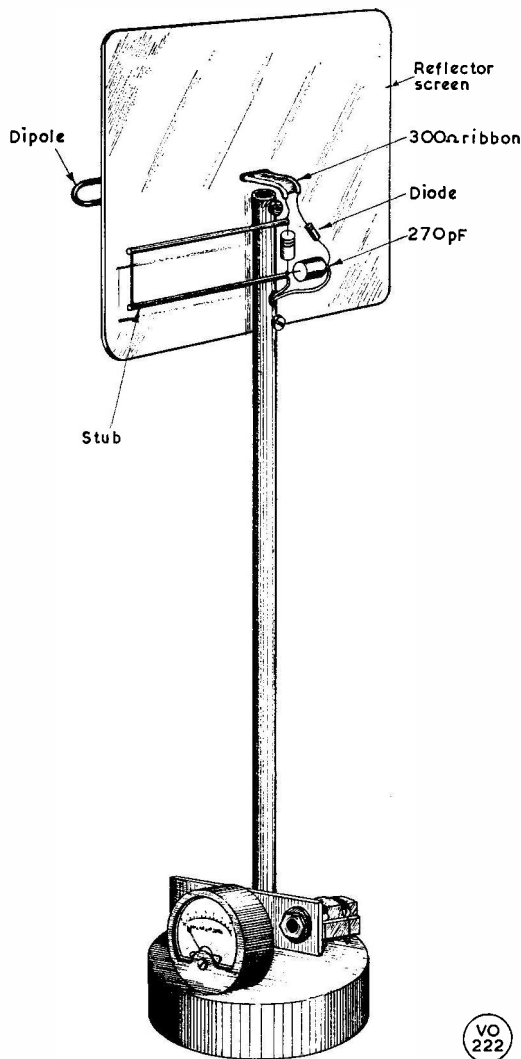

tube. This strip also carries a closed circuit jack to enable high impedance headphones to be used for monitoring modulated signals. The output leads are taken up through the base and connected to the meter, taking care that enough length is allowed for rotation. This form of construction makes a very neat job and the meter can be swung into any convenient position to face the observer when readings are being taken.

The 300-ohm resistor mentioned is only used during the adjustment of the matching stub and is then removed. As may be seen from the drawing, this stub consists of two 3in. lengths of 28g. tinned copper wire spaced one inch apart.

With the Tx running and the instrument placed so that the meter reads about half scale, a shorting bar is fitted to the ends of the stub remote from the resistor and gradually moved inwards until a maximum is noted on the meter. The shorting bar is then soldered into that

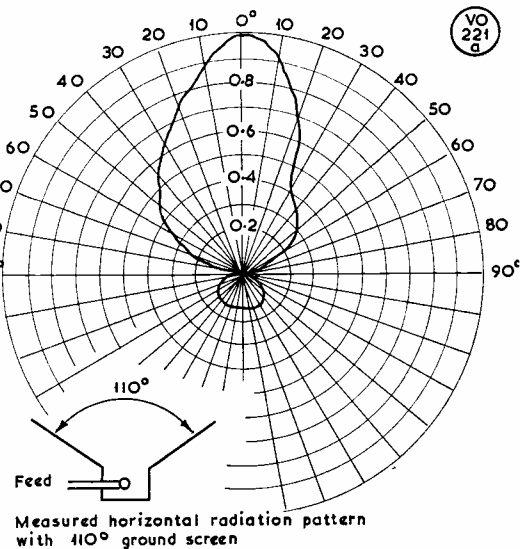
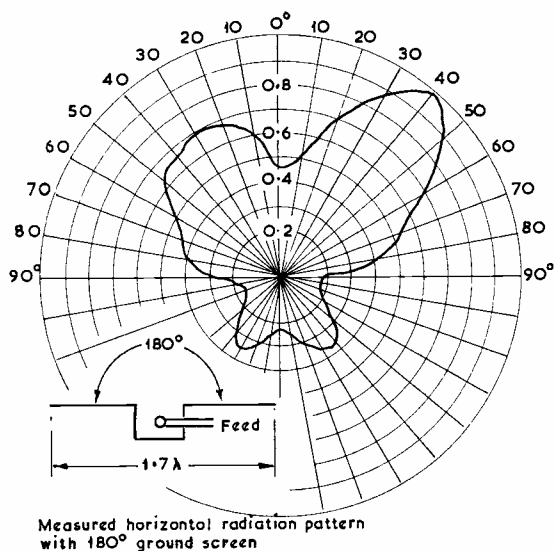

position and the surplus ends, as well as the resistor, are snipped off. This matching will show something like a 25% increase over the reading with the resistor alone.

Fig. 2. Polar diagrams obtained with the F/S Meter—note the improvement with the reflector wings at 110°.

SPECIALLY ON THE AIR

There are several new entries under this heading, as below. Those concerned with organisation of Special-Event stations are reminded that we should be given the details on a separate sheet, set out as shown here, and addressed "Specially on The Air," SHORT WAVE MAGAZINE, BUCKINGHAM, MK18 1RQ.

GB3BSP, April 21-23: For the Banks Steam Party, to be held at Hoole Lane, Banks, Nr. Southport, Lancs., over the Easter Holiday and organised by Ainsdale Radio Club, running all bands 2-160m., with talk-in for visitors on Top Band, 70.26 and 145 MHz. QSL's and information: G3LWK or G3VNQ, both *QTHR*.

GB3STF, May 12-13: From the Grammar School, Priory Road, Spalding, Lincs., by the Spalding & District Amateur Radio Society, running CW/SSB on all bands 10-160m. (and AM on two metres), all contacts to be confirmed by special QSL card—Details from R. Harrison, G3VPR, 38 Park Avenue, Spalding, Lincs.

GB2OCC, May 16-June 15: To be operated by Keele University Amateur Radio Society, in co-operation with other North Staffs. groups, for the Newcastle-Under-Lyme Octocentenary Charter Celebrations. Operator and SWL assistance is requested for station manning. Contact G3COY or G3UOK, *QTHR*, telephone *Stoke-on-Trent* 44875 or *Keele Park* 371, extn. 128.

GB3HCF, May 25-June 3: For the Hereford Cider Festival, mounted by the Hereford Amateur Radio

Society, running all HF bands (but mainly 20m. and 80m.) also RTTY. Enquiries: S. Jesson, 181 Kings Acre, Hereford, HR4 OSP.

GB2BWS, May 30-June 2: For the Bath & West Show, from the Shepton Mallet, Somerset, showground. Loan of equipment and operating assistance are solicited, conferring free admission for car and/or caravan. Anyone who can help is asked to get in touch with R. B. Holman, G2DYM, The Old Saw Mills, White Ball, Wellington, Somerset.

GB2FJE, June 13-14: From the Shefford Community Centre, put on by the Shefford & District Amateur Radio Society, operating 2m. and 160m. AM, 10-15-20m. SSB. Contacts to be QSL's by special card.—D. Pike, G3VMI, 11 Hazel Grove, Stotfold, Hitchin, Herts.

GB3HCW, June 30-July 7: Operating all bands Top to two metres, with three stations on the air. This event is in conjunction with the Hanworth Carnival Week.—V. W. Higgs, G3VWJ, 205 Commercial Road, Staines, Middlesex, TW18 2QT.

GB2GB, August: Station to be operated from Brunel's famous old steamship *Great Britain*, now dry-docked, at Bristol, for the City's charter anniversary celebrations. GB2GB will be available for operation by visiting licensed amateurs during the entire month. Contacts will be QSL'd by special card. Information from G. Mather, G3GKA, 8 Hills Close, Keynsham, Bristol.